

KUBOTA



KUBOTA WORKSHOP PRODUCTS CATALOG

RELIABILITY FOR THE JOB AHEAD

2024



Kubota

As the #1 builder of under-100 HP multi-cylinder, non-automotive diesel engines in the world, Kubota literally powers the industry.

That didn't happen by accident. It happened because we are committed to engineering excellence so that our customers can focus on planting, feeding, building and caring for our world.

Kubota has expanded its program once again and we're honored to be your first choice in aftermarket parts. We've added a variety of new products to make life even more productive and enjoyable on the farm, ranch, nursery, job site or wherever you call home.



CONTENTS

RADIOS & OBSERVATION KITS

Radios2
Custom SSV & SVL Kits4
Excavator Kits5
Radio Accessories6

RTV ACCESSORIES

RTV Accessories8
---------------------------	----

LUBRICATION PRODUCTS

Grease	12
Grease Guns	13
Lubrication	14
Filter Wrenches	17

FUEL & OIL EQUIPMENT

DEF Kits	18
Pumps	19
Fuel Containers	20
Funnels	21
Oil Change	22

CHEMICALS

Chemicals	23
Spill Containment	30

CARGO CONTROL

Ratchet Straps	32
Tie Downs	33
Tarp Straps	34
Cargo Control	35

CHAINS

Safety Chains & Tire Chains	36
Tow Chains	40
Hooks & Load Binders	41

LIFT EQUIPMENT

Lift Equipment	42
--------------------------	----

SHOP PRODUCTS

Lights	43
Hose Wraps	46
Shop Products	47
Hand Tools	48

TOWING & TIRE ACCESSORIES

Towing Hitches & Kits	50
Towing Diagnostic Tools	51
Tire Kit, Inflator & Gauges	52

SAFETY PRODUCTS

Safety Products	53
Gloves	56

BATTERY MAINTENANCE

Battery Jumpstart	58
Battery Charging	61
Battery Treatment	64

TURF & LANDSCAPE ACCESSORIES

Turf & Landscape Accessories	65
--	----

TOOL STORAGE

Chests & Cabinets	66
Cargo & Tool Storage	67
Tool Bags	68
BIGTOOLRACK®	69

SPRAYERS

Sprayers	71
--------------------	----

MOISTURE TESTERS

Portable Grain & Hay Moisture Testers	75
---	----

AM/FM/WX/BT/PA/USB Heavy Duty Short Din Style Radio

77700-13484

NEW



- 180 watts max power (45W x 4); 100 watts RMS (25W x 4)
- Bluetooth® streaming audio (A2DP/AVRCP)
- Water and UV resistant front panel (IPX5)
- Weatherband & AM/FM tuner with 30 presets
- Rear USB port for device charging (1 amp output)
- PA microphone input, low battery alert, work timer
- Toggle switch between day and night display
- 2-wire power with non-volatile memory and clock support

AM/FM/RBDS/WB/USB/BT/DAB+ Heavy Duty Mini Radio

77700-13486

NEW



- 50 watts max power (25W x 2); 20 watts RMS (10W x 2)
- Bluetooth® streaming audio (A2DP/AVRCP) and hands-free calling (HFP)
- Water and UV resistant front panel (IPX6)
- App control ready
- DAB+ (Digital Audio Broadcasting)
- Weatherband & AM/FM tuner with 30 presets
- RBDS (Radio Broadcast Data Service) with PTY search
- Rear USB port for device charging (1 amp output)
- Toggle switch between day and night display
- 2-wire power with non-volatile memory and clock support
- Remote turn on, low battery alert, work timer
- Compatible with 77700-04786 and 77700-08969 microphones (sold separately)

AM/FM/WX/BT/USB/DAB+/RBDS/CAN Heavy Duty Short Din Style Radio

77700-13485

NEW



- 180 watts max power (45W x 4); 100 watts RMS (25W x 4)
- Bluetooth® streaming audio (A2DP/AVRCP)
- Hands-free calling (HFP)
- Water and UV resistant front panel (IPX5)
- App control ready
- DAB+ (Digital Audio Broadcasting)
- Weatherband & AM/FM tuner with 30 presets
- RBDS (Radio Broadcast Data Service) with PTY search
- Rear USB port for device charging (1 amp output)
- Toggle switch between day and night display
- 2-wire power with non-volatile memory and clock support
- Remote turn on, low battery alert, work timer
- J1939 CAN Bus capability
- Requires customer-specific interface
- Includes Bluetooth microphone (77700-04786)



NEW



AM/FM/WB/USB/BT Heavy Duty Mini Radio

77700-13554

- 50 watts max power (25W x 2); 20 watts RMS (10W x 2)
- Bluetooth® streaming audio (A2DP/AVRCP)
- Water and UV resistant front panel (IPX6)
- Weatherband & AM/FM tuner with 30 presets
- RBDS (Radio Broadcast Data Service) with PTY search
- Rear USB port for device charging (1 amp output)
- Toggle switch between day and night display
- 2-wire power with non-volatile memory and clock support
- Remote turn on, low battery alert, work timer
- Compatible with 77700-04786 and 77700-08969 microphones (sold separately)

AM/FM/WB/USB Mini Bluetooth® Stereo

77700-09065

- Max. power output: 160W (40W x 4)
- Receives Bluetooth streaming audio (A2DP) and controls BT enabled devices (AVRCP)
- Waterproof (IPX6)
- Seven-channel NOAA weatherband tuner
- 30 programmable station presets
- iPod®/iPhone® ready via USB (rear pig tail)
- Auxiliary audio input (rear RCA pair)
- Multiple mounting options: front flush mount, rear flush mount and surface mount with the AMPS pattern
- White LED backlit dot matrix LCD display and buttons
- Wired remote control ready
- Corrosion and UV-resistant



SSV Observation Camera Kit

77700-08974

- Kit includes:
 - Monitor (77700-08976)
 - Fixed angle waterproof camera (77700-09106)
 - Camera mounting bracket
 - Power harness for Kubota SSV
 - Y adapter for Kubota SSV
- Ball mount 2 x 1.7
- 4" double mount
- Various hardware and cable



SVL Radio Kit

CAB 77700-04787

ROPS 77700-06119

- Kit includes:
 - MINI Radio (77700-04752)
 - Waterproof Speakers (77700-04759)
 - 14" Rubber Mast Antenna (77700-04761)
 - Mounting brackets
 - Adapter harness



SVL Radio Kit with Bluetooth®

CAB 77700-04797

ROPS 77700-06120

- Kit includes:
 - **Bluetooth** MINI Radio
 - Waterproof Speakers (77700-04759)
 - 14" Rubber Mast Antenna (77700-04761)
 - Mounting brackets
 - Adapter harness

Radio Kits for Excavators

77700-13484A & 77700-13484B

77700-13485A & 77700-13485B

- Radio kits include DIN radio indicated by model number
- "A" kit includes:
 - Bullet connector KUB2 (77700-04789)
 - Applications include: U35-4, KX040-4, KX057-4, U55-4 (cab and non-cab models)
- "B" kit includes:
 - ISO male to ISO female double 8-pin connector, KUB3 (77700-05318)
 - Applications include: U27-4 (cab model)

77700-13484A & 77700-13484B



77700-13485A & 77700-13485B



EXCAVATOR KITS

Wireless Camera System

77700-13386

NEW

Monitor:

- Bright 7" display
- Supports up to four wireless cameras simultaneously
- Auto-Pairing capability allows monitor to be paired with any of the wireless cameras with the touch of a button
- Strong signal transmits through and around objects up to 60' away
- Supports normal and mirrored camera image
- Supports Single, Split, and Quadview camera views
- Built-in speaker
- Suction cup mount and 12V DC plug included



Camera:

- 12V DC power
- High-performance color optics
- CMOS Sensor technology
- IR LED low-light assist
- Waterproof
- Integrated microphone
- Wide viewing angle

Voyager Rear Observation Kit for Cab SVL Machines

77700-06141

SVL95-2 Machines

77700-07933

Kit includes:

- 4.3" Heavy-Duty Monitor (7770006201)
- Waterproof CMOS Color Camera (77700-06202)
- Camera bracket
- Monitor bracket
- Power harness
- Y connector
- Hardware
- **Optional 15' Extension Cable available, sold separately (77700-06271)**



Short-Range Wi-Fi Transmitter

77700-13388

NEW

- Turns your smart device into a camera monitor
- Transmits two-way split video over Wi-Fi with 100 meter range
- Supports up to two Voyager wired cameras (sold separately) at a time
- Voyager Vision app supports Pinch/Zoom/Normal/Mirror, and Optional user adjustable marker OSD lines, and snap shot image
- Designed for low-speed maneuvering and stationary observation/surveillance
- Waterproof (IP67)
- Any tow vehicle can haul any trailer and be connected
- 12V DC power



All Makes Observation Kit with 4.3" Monitor

77700-08975

- Built for severe duty environments
- CMOS Color 125° with Built-in Microphone (77700-09107)
- Excellent night vision
- Three camera capability
- Bright 4.3" LCD display with anti-glare/scratch protective lens (77700-08976)
- Image orientation: mirror (reversed)
- 15 ft. cable and 4 inch monitor mount included



3" Universal Mount Two-Way Speakers

77700-12847

- 60W (30W RMS) max handling power
- Waterproof bridged woofer/tweeter
- Rear AMPS mounting pattern for additional mounting options



Heavy Duty 4-Channel Bluetooth Audio Amplifier

77700-12848

- 4 Channel audio amplifier configurable for Bluetooth or auxiliary input
- 4 x 40 Watt max power rating
- 4 x 26 Watt RMS
- Flush mount lighted chrome switch
- Waterproof to IPx6



4.3" Observation Monitor

77700-08976

- Three camera capability
- IPX6 rating
- Bright 4.3" LCD display with anti-glare/scratch protective lens

- Display graphic overlay shows real-time distance from objects
- Built-in speaker
- Manual or automatic source selection

Bluetooth® Microphones

- Works with all Jensen Heavy Duty Bluetooth-enabled radios



77700-04786



77700-08969

Item No.	Description
77700-04786	Visor clip
77700-08969	Panel mount

77700-04759



77700-04760



77700-06376



77700-06375

Speakers

Item No.	Description	Power	Sold
77700-04759	3.5" Heavy Duty Waterproof Surface Mount	120W Max.	Pair
77700-04760	4" Heavy Duty Waterproof	120W Max.	Individually
77700-06375	4" Weather Resistant Black metal grilles sold separately (77700-06376)	30W Max.	Individually

Bullet Connectors

- For use with 77700-13485 and 77700-13484 stereos



77700-04788

Item No.	Description
77700-04788	9-pin connector to Din radio KUB1
77700-04789	Bullet connector to Din radio KUB2
77700-05318	ISO male to ISO female double 8-pin connector KUB3

Radio Harnesses

- Your Kubota dealer offers a wide variety of harnesses that can be used to install these radios into many makes and models of equipment



77700-05318

Item No.	Description
77700-05368	All Makes Case Crawlers
77700-05318	All Makes CNH Current Models
77700-05319	All Makes CNH Old Models
77700-05369	All Makes Universal

RADIO ACCESSORIES

Portable Water-Resistant Bluetooth Speaker & Mounting Clamps

77700-12846

- Dynamic 20W portable speaker to take the music with you
- Powerful 57mm driver for high definition sound clarities
- Built-in equalizer allows mode adjustment for better sound output
- Built-in microphone to receive phone calls
- Durable construction, impact-proof & water-resistant ABS body with rubber coating & IPX6 rating
- Durable nylon composite clamps keep speaker secure
- Designed for fast and easy attachment/removal
- Clamps fit roll bars 1.625" to 2" diameter



Dimensions:
10"W x 4"H x 4"D



Universal Clamp System

14" or 6" Top or Side Mount Rubber Mast Antenna

77700-04762



77700-04761



Item No.	Description
77700-04761	14" antenna with attached 59" cable
77700-04762	6" antenna with attached 39" cable

SiriusXM Satellite Tuner

77700-05478

- For use with SiriusXM Ready Stereos
- Compact size hides discreetly behind the dash for a fully integrated look
- Includes one magnetic antenna
- Subscription required
- Not compatible with 77700-13484, -13485, -13486, -13554 radios (radios are not SiriusXM ready)



NEW



Dual USB Charger

77700-13387

- Epoxy-coated PCB for durability and superior protection against water
- Includes waterproof, tight rubber cover for increased water-resistance
- Panel mount dual USB charger with 1 USB-C port and 1 USB-A port
- 4.8 Amps charging current (2.4A x 2)
- Blue LED illuminated face for easy detection
- 12V DC



LED Work Light Kits

2 Pack Front Mount 77700-11933 *Fits RTV-520*
Single Rear Mount 77700-11934 *Fits RTV-520*

2 Pack Front Mount 77700-11811 *Fits RTV-X1100C*
Single Rear Mount 77700-11812 *Fits RTV-X1100C*

- Six high intensity LEDs
- Ideal for off-road driving only
- Measured lumen: 1,000 lm
- Multi-volt 10-30V DC
- Mounting: upright or flush
- Dimensions: 6-3/8" W x 1-7/8" H x 2-1/2" D

Hazard Light Kit

77700-VC5057A

- Black flange weatherproof housing for indoor or outdoor use
- 18 different flash patterns to choose from
- Four high-impact three 1-watt LED amber lightheads 12/24V
- Illuminated high quality rocker switch
- Dimensions: 5-3/16" W x 3-3/8" H x 1-7/8" D
- **Fits RTV-X900, RTV-X1120, RTV-X1140**

Work Light Kit

Single Rear Mount
 77700-VC5051A
Fits RTV-X900, RTV-X1120, RTV-X1140

2 Pack Front Mount
 77700-VC5050
Fits RTV-X900, RTV-X1120

- Six high intensity LEDs on each light
- Illuminated, high quality rocker switch
- Measured lumen: 1,000 lm
- Multivolt 10-30V DC
- 18W flood beam



77700-VC5051A



77700-VC5050



RTV ACCESSORIES

Strobe Light Kit

77700-V4318

- 12/24V single strobe light, 0.30 amperes
- Through bolt permanent mount
- Linear strobe bulb with rubber base and polycarbonate lens
- On/off toggle switch and automotive relay included
- **Fits RTV500**



Strobe Light Kits

Strobe Light 77700-VC5058

Fits RTV-X1100

LED Strobe Light Kit

77700-VC5056

Fits RTV-X900, RTV-X1120, RTV-X1140

- Amber beacon features 70 FPM pulse, 8 flash patterns
- Illuminated, high quality rocker switch
- SAE J845 Class III, CE, R10, UL amber beacon
- 12-80VDC, 2.7 Amps
- Reverse polarity



Strobe Light Mounting Bracket

77700-V4284

- Sturdy 10GA cold-rolled steel for secure mounting
- Durable UV-resistant powder paint for long lasting durability
- **Fits RTV1100**



Wire Harness Kit

77700-VC5081

- For single electrical accessory or light
- In-line fuse for circuit protection
- Automotive relay included
- **Fits RTV-X900, RTV-X1120**

Rear View Mirror

77700-10705

- Compatible with most windshields and roll cages from 1.25" to 2"
- Slightly convex shape increases field of view without image distortion
- Integrated, Kubota low profile mount provides a cleaner look
- The tool free adjustment design enables convenient and easy adjustments on the fly
- Built-in anti-vibration technology enhances clarity of mirror



Side View Mirror

77700-10706

- Huge field of view
- Universal mounting
- Dual axis breakaway
- Three-way adjustment
- Adjustable blind spot mirror
- Anti-vibration technology
- Fits 1.25" to 2" roll cages
- Fits left or right side
- Easily return mirror to your preset position each time it breaks away for consistent viewing alignment



Wire Harness Switch Panel

77700-VC5080

- Includes painted switch panel for mounting five additional accessory switches
- Panel plugs for un-used positions
- Six position Fuse Block for circuit protection
- Vinyl dust cover to protect Fuse Block
- In-line fuse for circuit protection
- Automotive relay included
- **RTV-X900, RTV-X1120**





Wiper Kit - Single 172° Sweep

77700-VC5030

- Keep rain, mud, dust from obstructing your view
- Large single wiper for laminated, tempered or hard-coated polycarbonate windshield
- **RTV-X900, RTV-X1120, RTV-X1140**

Fire Extinguisher Mount

77700-10709

- Secures fire extinguishers up to 3.5" in diameter
- Universal design mounts to round tube roll cages up to 2.25"
- Patented low-profile mounting
- Adjustable clamps secure most fire extinguishers
- Fire extinguisher not included



Safety Dust Mask



Bandana Style Dust Mask



Neoprene Dust Mask

Dust Masks

- Washable and reusable
- Improved design provides maximum comfort
- No replacement filters needed
- Compatible with open and closed face helmets and goggles

Item No.	Description
77700-10710	Universal Safety Dust Mask
77700-10712	Camo Safety Dust Mask
77700-10713	Neoprene Dust Mask
77700-10714	Red Bandana Style Dust Mask
77700-10715	Black Bandana Style Dust Mask

ShockStrap® Load-Absorbing Ratchet Straps

- **Dependable** - a ShockStrap provides superior shock absorption without coming loose—keeps tension on the strap
- **Safety Strap** - a backup strap in case the ShockStrap is compromised
- **Durable** - made from our proprietary formula that is not affected by most chemicals, sunlight, oil, salt water, fungus or moisture
- **Rust Resistant** - hooks and buckle are yellow zinc coated, which lasts 8 to 10 times longer than chrome plating
- **Soft Loop** - flexibility to always find a way to secure your load
- **2 - Pack Card** - with informative text and product images

Item No.	L x W	Break Strength	Work Load
77700-10680	9' x 2"	6,000 lbs.	2,000 lbs.
77700-10681	18' x 2"	6,000 lbs.	2,000 lbs.



RTV ACCESSORIES



Cargo Bed Seal Kit

77700-11096

- Perfectly sized plate fills the gap
- Ideal for protection against debris falling into the engine bay below the cargo bed
- Fits RTV-X900, RTV-X1100C, RTV-X1120

Deluxe RTV Cargo Box

77700-08760

- Requires two pairs of KAS Clamps (7811-99560) and one Mounting Bracket (77700-V0838) (must be ordered separately)
- Kubota engineering designed and approved Deluxe RTV Bed Box features 4.5 cu. ft. of cargo capacity
- Tough and durable polyethylene construction resists corrosion, water and dust
- Lockable latches to secure your cargo
- Easy-to-lift covers with lock in detents providing easy access from either side of the box
- Sliding and removable tool trays for better organization
- Fits RTV-X900, RTV-X1100, RTV-X1120, RTV-X1140 and RTV-XG850



K7811-99560, must be ordered separately

Premium Roof Radio & Speaker Kit

77700-VP0897

- Custom fit for RTV premium roof (77700-VP0801A)—roof sold separately
- Rugged Jensen Bluetooth audio system offers AM/FM, USB and AUX inputs
- Includes two Jensen speakers
- Not compatible with the Sport Roof (77700-VP0800)
- Requires Accessories Wiring Harness (77700-V0881)
- AM/FM/WB/USB Mini Bluetooth® Stereo (77700-09065)



RTV Tow Strap

77700-08977

- 1-1/4" X 12' tow strap with loops and shackle
- 5,000 lbs. break strength
- Forged shackle
- Reinforced attachment loops



Recovery Rope

77700-13410

- 100% double braided nylon rope
- 6" eye loops with protective nylon sleeves to minimize abrasion
- Rope stretches up to 30% of its original length and "slingshots" the stuck vehicle
- 45% stronger and lighter than wire rope winch line
- Safer than wire rope or chains if the line breaks
- 7300 lbs. breaking strength
- 1/2" x 20'

NEW

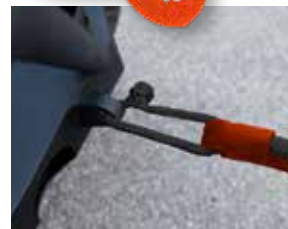

Cargo Net

77700-08978

- 34" x 34" — stretches to 60" x 60"
- Heavy duty plastic hooks prevent scratching
- Finger holes in hooks for safety and easy hook up
- Weather resistant
- Secures odd, bulky shapes
- Adjustable hooks
- Fits most UTV/RTV Bed Boxes

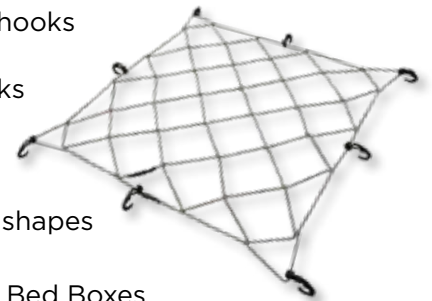

Soft Shackle for Recovery Rope

77700-13411

- Made of Ultra High Molecular Weight Polyethylene (UHMWP)
- Effective way to quickly hook onto a vehicle and carry large loads.
- Dries quickly - fibers do not absorb water.
- 33000 lbs. breaking strength
- Length: 22-3/4"
- Diameter: 7/16"

NEW





High-Performance Synthetic Extreme Duty Grease

Synthetic Food Grade NLGI 2, GC-LB rated, extreme pressure grease with PTFE micro powders. Designed for use in agricultural, construction, automotive, recreational and industrial applications.

- Corrosion protection—impervious to salt water
- Lasts 3–4 times longer than petroleum based products
- Will not run or drip and does not evaporate
- Compatible with most other greases
- Non-toxic, clean, non-staining
- Operating temperature range -45°F to +450°F
- NSF Registered (H-1 Safe for incidental food contact) meets 1998 USDA Guidelines—approved for use in a federally inspected beef or poultry processing facility

Item No.	Description
77700-06321	14 oz.

High-Performance Polyurea Multi-Purpose Grease

Premium Polyurea thickened, NLGI 2, GC-LB rated extreme pressure grease. Designed for use in agricultural, construction, automotive, recreational and industrial applications.

- Superior rust and corrosion protection
- Excellent resistance to water wash out
- Compatible with most other greases (shear stable)
- Outstanding high temperature stability for long service life
- Operating temperature range -30°F to +350°F

Item No.	Description
70000-10701	14 oz.
77700-03523	3 oz. (Pack of 2)

High-Performance Moly-Lithium All-Purpose Heavy Duty Grease

Specially formulated lithium complex with 3% molybdenum disulfide/graphite NLGI 2, GC-LB rated extreme pressure grease. Designed for use in agricultural, construction, automotive and industrial applications.

- Will not plate out forming an adhering film on metallic surfaces reducing the coefficient of friction
- Molybdenum disulfide/graphite will act as a dry lubricant when necessary
- Cost effective
- Ideal for metal to metal applications
- Operating temperature range 0°F to +350°F

Item No.	Description
70000-10401	14 oz.

High-Performance Lithium Complex Standard Duty Grease

Ideally suited for on/off road applications, wheel bearings, axles, ball joints/U-joints, PTO's, commercial lawn mowers, track rollers, general purpose shop/industrial applications.

- High dropping point in excess of 500° F, ensures retention in extreme temperature conditions
- Excellent natural oxidation inhibition
- Specially formulated to provide high film strength, extreme pressure and anti-wear properties
- Operating temperature range -40°F to 325°F

Item No.	Description
77700-10698	14 oz.

GREASE GUNS

20V* Cordless Grease Gun

77700-12838

- Powerful 20V high torque motor, clears clogged fittings with ease
- Long lasting 18.5V Lithium-Ion battery for maximum performance, features a quick 1 hour recharge time
- Up to 10,000 PSI (690 BAR)
- 2-Speed Gearbox - choose between high pressure and high flow
- Grease output up to 3 oz. (85 grams) per minute in free flow
- Automatic air bleeder & bulk loader
- High pressure 40" hose with grease coupler features spring guards on both ends (prevents kinking)
- Convenient, integrated foot design for flat surfaces



18.5V Lithium-Ion battery and Quick-Charge battery charger



Digital display panel indicates:
 • Battery level
 • Grease level
 • Unit of dispensing
 • Pump speed



On-board LED light for low-light conditions

Item No.	Replacement Accessories
77700-06346	30" Replacement Hose
77700-12965	Rechargeable Battery, 18.5V 2000 mAh Li-ion
77700-12966	1 Hour UL listed Battery Charger, 110V/60 Hz, 20v

* Maximum initial battery voltage (measured without a workload) is 20 volts. Nominal voltage is 18.5 volts.

Lubrication Products

Heavy Duty Construction Grade Pistol/Lever Handle Dual Action Grease Gun

77700-12835



2-Way Operating Telescopic Handle

- Pistol handle provides 4,500 PSI, lever handle provides up to 7,000 PSI
- Non-slip comfort grip pistol handle ideal for use in confined areas
- Lever handle ideal for higher pressure and high volume applications
- Aluminum die cast head fitted with bulk loader and airbleeder valve
- Rugged 0.049" thick dent-resistant barrel construction
- Shift between high volume and high pressure greasing
- Dual discharge posts - front port for pistol mode and top port for lever mode
- For use with 14 oz. grease cartridge
- Includes 6" bent steel extension & 18" flexible hose extension with coupler

Heavy Duty Construction Grade Pistol Grip Grease Gun

77700-09766

- 7,000 PSI
- Aluminum barrel
- Cold weather design with venturi grease inlet
- Grease gun head fitted with bulk loader that doubles as an air release
- 14 oz. capacity
- Includes 18" flexible hose extension & 4-jaw coupler



Heavy Duty Construction Grade Lever Action Grease Gun

77700-09767

- 10,000 PSI
- Lightweight aluminum barrel reduces fatigue, ideal for overhead applications
- Grease gun head fitted with bulk loader and air bleeder
- Extra strong lever handle with built-in variable stroke
- 14 oz. capacity
- Includes 6" bent steel extension & 4-jaw coupler



Pistol Grip Grease Gun

77700-02470

- Heavy duty aluminum die cast head with air bleeder
- Comfortable one-hand operation
- Heavy duty pistol handle with rubber grip
- Develops 6,000 PSI
 - 3-way loading (14 oz. cartridge, suction and hand fill or with filler pump)
 - Includes 18" flexible hose extension and 4-jaw coupler



Lever Action Grease Gun

77700-02471

- Heavy duty aluminum die cast head with air bleeder
- Built-in variable stroke mechanism
- Heavy duty lever handle with grip
- Develops 10,000 PSI
- 3-way loading (14 oz. cartridge, suction and hand fill or with filler pump)
- Includes 6" steel extension and 4-jaw coupler



Mini Lever Action Grease Gun with 2 Grease Cartridges

77700-03644

2 Pack Refill (Grease Only)—77700-03523

- Aluminum die cast head
- Develops 6,000 PSI—highest in its class
- 2-way loading (3 oz. cartridge or suction)
 - Push lock plunger and plastic T-handle locks in place
 - Includes 6" steel extension, 4-jaw coupler and two 3 oz. cartridges
 - Two 3 oz. refill cartridges feature High-Performance Polyurea Multi-Purpose NLGI #2 grease—excellent resistance to water washout and corrosion



77700-03523



Grease Bearing Packer

77700-12836

- No mess, no hassle greasing solution for packing bearings
- Quickly and easily flush out old grease and repack bearings with fresh grease—without the mess!
- Grease stays in the packer housing, not on your hands
- Cap protects grease from contaminants when not in use
- Accommodates up to 3-1/2" diameter bearing



LUBRICATION

Lubrication Kit

77700-12958

- Multi-purpose lubrication kit to keep your equipment running smoothly in all weather and temperature conditions
- Kit includes everything you need to complete a greasing project across multiple machines and uses to keep your equipment running efficiently
- Designed for agricultural, construction, automotive, recreational, and industrial applications
- Heavy duty storage bag



77700-06282

80 Piece SAE Grease Fitting Kit

77700-06282



Threads	Straight	45°	90°
1/8" - 27 PTF	25	10	10
1/4" - 28 SAE-LT	15	10	10

80 Piece Metric Grease Fitting Kit

77700-06283

Threads	Straight	90°
M6 x 1	20	10
M8 x 1	15	10
M10 x 1	15	10

Quick Lock Extended Reach Coupler

77700-13528

- For hand, air & battery operated grease guns
- No leaks once locked on
- Hands-free operation
- Rated up to 8,000 PSI
- Works with both SAE and metric fittings



NEW

Quick-Lock Coupler

77700-09000



- Quick-Lock thumb trigger releases back pressure on couplers
- No leaks once locked on
- Hands-free operation

- Rated up to 8,000 PSI
- Compatible with all grease guns
- Works with both SAE and metric fittings
- Releases from clogged grease fittings, under any pressure load

Quick Release Coupler Display

77700-10041

- Interactive countertop display for hands-on testing
- Rugged metal construction with informative graphics
- Includes six of the 77700-09000 Quick Lock Couplers for easy point of sale



Hydraulic 360° Swiveling Coupler

77700-13488

Working Pressure up to 480 BAR / 7000 PSI. Swivels in full 360° circle & locks conveniently at any 45° position, which gives easy access to most grease fittings.



- Excellent coupler for effective lubrication of difficult and hard-to-reach grease fittings
- Jaws are fully hardened for extended service life
- Hardened coupler body and swivel joints withstand high-pressure applications without deformation
- Zinc plated finish
- Spring loaded ball check valve helps retain pressure

4-Jaw Coupler

77700-03383

- Working pressure of 6,000 PSI
- Hardened coupler body
- Hexagonal nut for easy tightening
- 1/8" NPT



90° Coupler

77700-09001

- Working pressure 69 BAR / 1,000 PSI
- Designed for greasing fittings with limited reach, especially in low height application
- For hand operated grease guns only



6" Steel Extension

77700-03384

- Straight adaptor
- 1/8" NPT



Heavy Duty Grease Gun Holder

77700-02474

- Rugged holder firmly secures standard size tube-style and most battery-operated grease guns
- Mount as needed with 1/4" carriage bolts (not included)



Grease Injector Needle

77700-03386

- Lubricates in tight spaces
- Equipped with standard grease fitting without check ball
- Includes plastic protective cover



6 Ounce Pistol Grip Oil Can

77700-03382

- All steel construction from tin-coated sheet
- 6" rigid spout
- Springless suction valve design provides trouble-free performance



Grease Joint Rejuvenator

77700-02453

- Unclog frozen grease joints
- Works on farming, excavating, construction, industrial equipment, aircraft, automobiles, trailers and more
- Includes 5" flex hose for hard-to-reach areas



Flexible Grease Hoses

12" 77700-02472

18" 77700-02473

- Flexible hose extension for hard-to-reach places
- Minimum radius bend of 1.57"
- Hose ID: .14" / OD: .33"
- Working Pressure up to 240 BAR / 3500 PSI



Grease Gun Holder

77700-03387

- Simple snap action design
- Perfect for safe and convenient storage of grease gun
- Mounts on almost any surface

Grease Fitting Tool

77700-03385

- Works with both straight & angled fittings
- Re-tapping holes for installing new grease fittings
- Designed for removing worn or broken threads
- Hex size: 5/16" (7 mm) and 3/8" (9 mm)
- Tap re-threads: 1/4"-28



FILTER WRENCHES

Oil Filter Wrench

- Features a swivel handle which allows users to get to filters in hard-to-reach areas
- Wide dimpled band securely grips filters without crushing
- Cushion grip vinyl handle

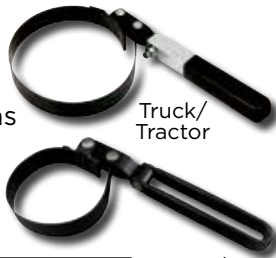

Item No.	Size	Filter Diameter
77700-03661	Small	2-13/16" to 3-5/32"
77700-03662	Medium	3-1/2" to 3-7/8"
77700-03663	Truck/Tractor	4-3/4" to 5-1/8"

Small/
Medium

Truck Filter Wrench

77700-03664

- Fits small diameter filters from 4-1/8" to 4-21/32" (105 mm to 118 mm)
- Wide 1-1/2" steel band designed to withstand the high torque requirements of truck, bus, RV and heavy duty equipment filters
- Use with 1/2" square drive



Full Range Filter Wrench Pliers

77700-03668

- 17" overall length with jaw range of 4-1/4" to 7"
- Full range pliers ideal for removing canister style filters from agriculture and construction equipment and vehicles
- Heavy duty forged construction
- Rubber grip handles provide leverage and extra reach
- Serrated teeth for better grip and grabbing power



Nylon Strap Oil Filter Wrench

77700-03665

- Adjusts quickly to any spin-on filter up to 6" in diameter
- Strong nylon web belt will not slip
- Use with 1/2" square drive

Filter Strap Wrench

77700-11842

- Accommodates up to 7" Diameter
- 12" Aluminum I-beam handle
- 36" Non-marring nylon strap for easy gripping of round, irregular shaped objects, tubes & pipes



DEF Tote Mounting Kits (Closed system, tote not included)

- **Basic with Micro Matic Coupler: 77700-06165**

Includes Electric 110V AC DEF Pump, Stainless Steel Tote Mounting Plate, Micro Matic RSV Dispense Coupler (744-048), Micro Matic RSV Container Valve (743-097) with Tote Adapter Cap and Down Tube, Inlet Hose (EPDM) 6' Long x 3/4" ID, Nylon Manual DEF Nozzle, Discharge Hose (EPDM) 20' Long x 3/4" ID, and Connecting Hardware

- **Advanced: 77700-06166**

Includes everything in the Basic with Micro Matic Valve kit (with exception of Nylon Manual DEF Nozzle) in addition to the SS Auto Shut-Off DEF Nozzle with Swivel

- **Premium: 77700-06167**

Includes everything in the Advanced kit, in addition to the DEF Digital Turbine Meter



DEF Drum Mounting Kits (Closed System, drum not included)

- **Basic with Micro Matic Coupler: 77700-06169**

Includes Electric 110V AC DEF Pump, Stainless Steel Drum Mounting Plate, Micro Matic RSV Dispense Coupler (744-048), Micro Matic RSV Container Valve (743-097) with Down Tube, Inlet Hose (EPDM) 4' Long x 3/4" ID, Nylon Manual DEF Nozzle, Discharge Hose (EPDM) 20' Long x 3/4" ID, and Connecting Hardware

- **Advanced: 77700-06170**

Includes everything in the Basic with Micro Matic Valve kit (with exception of Nylon Manual DEF Nozzle) in addition to the SS Auto Shut-Off DEF Nozzle with Swivel

- **Premium: 77700-06171**

Includes everything in the Advanced kit, in addition to the DEF Digital Turbine Meter



Micro Matic RSV Dispense Coupler 744-048

77700-06178

- Features VITON seals and 3/4" hose barb outlet that attaches to the suction side of the pump hose
- Used to connect to the container valve for clean, safe closed-system dispensing
- Self-venting coupler allows air into the container to produce a smooth flow
- 90° angle with 3/4" fittings
- Dependable VITON seals for leak-resistant performance



Micro Matic RSV Container Valve 743-097

77700-09082

- 2.5" x 5 Buttress Thread with EPDM seals
- Connects the RSV Micro Matic Dispense Coupler (77700-06178) to Tote or Drum for a closed system (Tote connection requires IBC Center Cap 749-326)
- AISI 304 Stainless Steel Construction

DEF Kit Accessories

Item No.	Description
77700-09083	Down Tube for Drum, 810 mm
77700-09084	Down Tube for Drum, 1,065 mm
77700-09085	6" ICB (Tote) Center Cap 749-326
77700-06172	Stainless Steel Tote Mounting Plate
77700-06173	Stainless Steel Drum Mounting Plate
77700-06174	Electric 110V AC DEF Pump
77700-06175	DEF Digital Turbine Meter
77700-06176	Nylon Manual DEF Nozzle
77700-06177	SS Auto Shut-Off DEF Nozzle with Swivel
77700-06181	Inlet Hose (EPDM) 6' Long x 3/4" ID
77700-06182	Discharge Hose (EPDM) 20' Long x 3/4" ID
77700-06183	Connecting Hardware

Drum Level Indicator

77700-09769

- Fits 3/4" holes on drums
- Convenient method to check remaining fluid level in a 55 gallon drum
- Indicator can be adjusted to show readings in gallons
- For use with oil, fuel, water and water based fluids, coolants, etc.



PUMPS

Lever Action Bucket Pump

77700-12948

- **Industrial Grade:** Recommended for transferring transmission differentials and heavier oils
- **Long Lasting:** Zinc plated pump body with aluminum die-cast head and adjusting flange
- **Quality Finish:** Powder coated steel drum cover is resistant to chipping, scratching, fading and wearing
- **Rugged Reliability:** Zinc die-cast piston fitted with wear resistant brass piston rings
- **Comes Complete:** With 48"/4' fuel resistant soft PVC hose with nozzle for efficient discharge
- *For use with 5 gallon buckets, sold separately (77700-12850)*

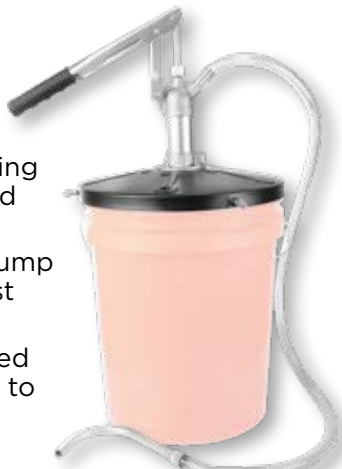

Plastic Lever Pump with 2" Bung Adapter

77700-09768

- Lever action barrel pump, designed for use with high viscosity oils, agricultural chemicals and more
- Built-In 2" bung adapter allows the pump to be fixed on drums with 2" opening
- Includes suction tube for use with 15-55 gallon drums & 6-1/2' x 3/4" flexible corrugated discharge hose
- Delivers up to 1 pint per stroke



Battery Operated Siphon Pump

77700-09771

- Multi-purpose siphon can pump up to 1.8 GPM (7 LPM)
- Powered by 2 "D" size batteries (not included)
- For use with light oils, diesel, kerosene, water & other water based media, etc.
- Suitable for use on 5 Gallons / 20 liters pails



Battery Operated Fluid Transfer Pump

77700-10673

- Provides quick transfer of fuel, diesel, DEF/Adblue, water & water based media
- Flow control nozzle
- Self-priming pump with 3V DC motor
- Flow rate: up to 2.3 GPM (9 LPM)
- Requires (2) D batteries (not included)



Battery Operated 14.8V Bucket Pump

77700-13406

- Rechargeable lithium-ion battery
- Quick stop & flow control safety nozzle
- For use with 5-7 gallon pails
- Flow rate: up to 4.5 GPM
- For use with gasoline, engine oil, diesel, kerosene, DEF, hydraulic fluid, antifreeze and more



NEW

Drum Cradle

77700-13400

- Versatile cradle tips, rotates, moves and stores 55 gallon drums / 400 lbs.
- Equipped with self storing lever bar
- Large 2-1/2" non-sparking wheels for easy mobility and suitable for flammable environments
- Powder coated finish for lasting durability



NEW

4 Wheel Drum Dolly

77700-13401

- Heavy duty 11 gauge steel construction easily moves 55 gallon drums in shop, rough work environments
- Durable powder coated finish resist corrosion, harsh elements
- Firmly welded 4 heavy duty caster



NEW

18.5V Battery Operated Drum Pump

77700-09770

- AC/DC rechargeable drum pump for use with 55 gal drums or IBC's
- 18.5V Li-ion battery and 1 hour quick charger
- Delivers up to 7.4 GPM
- For use with diesel, kerosene, DEF, Adblue™, antifreeze, detergents, soap solutions, pesticides, herbicides and water based media



SureCans

- Rotating nozzle dispenses fuel from the bottom for total ease of use and allows you to reach those awkward fill locations
- Allows user to control the flow speed with their hand - not their back
- Self-venting valve ensures consistent flow
- No tipping or applying pressure to the nozzle in order to use the product
- Six layer HDPE making the SureCan the most durable fuel can available
- All SureCan products come with a 3-year warranty
- FM Approved and meets OSHA, CARB, NFPA, and MSHA Type-II Safety Can Guidelines



Item No.	Description	Fuel Type
77700-10682	2.2 Gallon	Gasoline
77700-13351	5 Gallon	Gasoline
77700-13352	5 Gallon	Diesel
77700-13353	5 Gallon	Kerosene

5 Gallon Type 1 Metal Safety Cans

- Spring-loaded, self-closing lid controls vapors, automatically closes after filling/pouring
- Rugged 24 gauge construction is guaranteed leak-proof
- Complies with OSHA 29 CFR 1910.106 and NFPA Code 30 requirements
- FM, UL, ULC certified
- Accepted container under CARB



Item No.	Fuel Type
77700-01541	Gasoline
77700-01542	Diesel
77700-03652	Kerosene



Gas Container Rack **NEW**

- 77700-13490
- Versatile rack can be mounted on either enclosed or open style trailers
 - Holds one 5 gal or two 2-1/2 gal polymer cans (not included)
 - Includes durable nylon strap
 - Black powder-coated steel resists rust for lasting durability

Plastic Fuel Containers

- Portable fuel containers come equipped with EPA/CARB compliant spouts and ANSI standards
- Easy-flow/spill-proof spout provides safe fuel storage and easy pouring

Item No.	Capacity	Fuel Type
77700-03647	1 Gallon	Gasoline
77700-03648	2 Gallon	Gasoline
77700-03649	5 Gallon	Gasoline
77700-03650	5 Gallon	Diesel
77700-03651	5 Gallon	Kerosene



18 oz. Quick Fill Portable Fuel Bottle

- 77700-10697
- Spill-proof—no caps to unscrew
 - Self-venting / auto shut-off



FUNNELS

Fluid Change Funnel

77700-11841

- Perfect for high accuracy oil applications
- On/off spout with tube and cap
- Easy grip handle for premixing
- Precision measuring and pouring
- Measuring increments from 1/2 pint to 1 quart



Fluid Change Syringe

77700-11843

- Enables easy removing of various fluids
- Includes an extension & adapter for greater reach
- For use with all types of vehicle fluid
- Easy-to-read volume scale
- Units of measure: QT / CC
- Max capacity: 0.21 QT / 200 CC

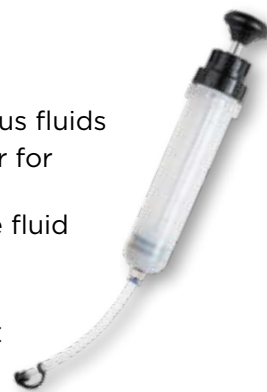

Auto-Stop Fuel Funnel

NEW

77700-13405

- 16 oz. polypropylene funnel
- Easy pour-off spout
- Built-in filter screen
- 5" top opening / 1" bottom spout ID opening



Portable Fuel Filter Funnel

- Dirty Fuel In....Pure Fuel Out
- Protect your investment and keep your engine running better, longer, more efficiently
- Unique filter technology features fluoropolymer-coated stainless steel filter
- Sump area collects deflected water and debris for proper disposal
- Works with gasoline, diesel, heating oil and kerosene



Universal Pour Spout Funnel

77700-01543

- For use with Type 1 safety cans and FM certified
- Attaches quickly for safe, leak-free pouring
- The innovative hinged design allows you to fill or pour from the can without removing the funnel and takes up less space during storage



OD: 1/2"

Item No.	Description
77700-08589	Small
77700-08590	Medium
77700-08591	Large

Capped & Standard Screened Funnels

- Ideal for agriculture and construction industry
- Fights contamination and promotes a clean workshop environment
- Screened funnels feature an in-spout safety screen that reduces contamination and an outer ribbing design that eliminates air lock

Item No.	Capacity	Top ID	Spout ID	Height
77700-03371	1 Pint	3"	1/2"	9-1/2"
77700-03372	1-1/4 Quart	4"	5/8"	10-1/2"
77700-03373	1-1/2 Quart	4"	5/8"	17"
77700-03374	1-1/2 Quart	4"	1-1/8"	13-1/4"
77700-03375	1 Pint	4-1/2"	1/2"	6"
77700-03376	2 Quart	6-1/2"	1-1/16"	8-1/2"
77700-03377	6 Quart	8-1/2"	1-5/16"	10-1/2"



77700-03373

77700-03374

77700-03372

77700-03371



77700-03375

77700-03376

77700-03377

3-Quart Drum Funnel

77700-08592

- Overall Height: 9-3/16"
- Top ID: 7-1/2"
- Spout Length: 1-7/16"
- Spout OD: 2-1/4"
- 2" Thread
- Max Temp: 250° F



18" Long Reach 1 Quart Funnel

77700-03378

- 18" spout ideal for hard-to-reach or confined areas
- Spout ID: 7/16"
- Top ID: 4-3/4"



1 Pint Funnel with 21" Flex Hose

77700-03379

- Spout ID: 1/2"
- Top ID: 5"
- Fights contamination and promotes a clean workshop
- Unique design prevents leftover fluid from dripping out



Pour Spouts

- Flexible spout ideal for hard-to-reach areas
- Includes cap to eliminate unwanted drips
- Chemically-resistant clear tube keeps contents visible



Item No.	Container/Pail Size
77700-03380	Quart, 1 Gallon & 5 Gallon
77700-03381	2-1/2 Gallon

Multi-Purpose On/Off Pour Spout

77700-03645

- On/off adjustable flow spout
- Fits quart or gallon containers
- Reduced tip for transmission filler tubes
- Flexible, clear tube keeps contents visible
- Fits in tight places



Oil Change Kit

77700-09765

- Convenient kit includes everything you need to change oil or fluids in any engine powered vehicle, maintenance equipment or outdoor power sports machine
- Includes: one 6.5 qt. drain pan, one 1-pint oil funnel, one 15" x 18" absorbent pad, two pairs nitrile gloves, four shop towels



Closed Drain Pan

- High density polyethylene drain pan for recycling of used oil
- Perfect for transporting waste fluids
- Closed design for safe & spill-free disposal
- 15 Qt. comes complete with wheels for slosh & spill free mobility



77700-12837

77700-12157

Item No.	Capacity	Dimensions
77700-12157	9 Quart	20.5" L x 13.25" W x 5.5" H
77700-12837	15 Quart	18" L x 16" W x 5" H

4 Gallon Oil Drain Pan

77700-02456

- 1" diameter pour spout built into the pan
- Overall height: 5-1/2"



Oil Drip Tray

77700-02455

- 22" x 22" x 1-1/2"
- 3 gallon capacity
- Chemically-resistant polypropylene



CHEMICALS

Clean & Shine™

- High-performance washless cleaner that cleans, shines, and protects
- Invisible protective coating protects surfaces and repels dirt, dust, fingerprints, smudges, and bugs
- Safe on plastic, leather, acrylic, plexiglass, Lexan, chrome, fiberglass, and paint
- Dries quickly and buffs to a streak-free finish
- Helps to resist scratching and marring of surfaces
- Repels water, prevents fogging, and is odorless and non-abrasive

Item No.	Description
77700-12824	2 oz.
77700-12825	16 oz.
77700-12826	32 oz.
77700-12827	Premium Microfiber Towel
77700-12828	Clean & Shine Kit



Scan the QR code to view a demo video!



Citrus Hand Cleaner Lotion

- A. 1 Gallon Smooth 77700-05580
- B. 15 oz. Smooth 77700-05579
- C. 1 Gallon Pumice 77700-05582
- D. 15 oz. Pumice 77700-05581

- Advanced cleaning and skin conditioning
- Contains premium-grade cleansing agents that quickly dissolve the toughest soils

Heavy-Duty Multi-Purpose Cleaning Wipes

- E. 77700-05578

- 90 count dual-textured wipes
- Convenient hand cleaner/scrubber wipe combination eliminates the need for water or towels

B3C Fuel Solutions products are engineered to keep equipment running and lasting longer by **IDENTIFYING (TESTING FOR)**, **FIXING** and **PREVENTING** fuel-related issues (like **water and contamination**) that can lead to engine starting and operating problems. B3C products help Do-It-Yourself (DIY), professional, and industrial users save time and money by avoiding repairs, downtime, and unnecessary costs.



Scan with phone camera for How-To-Use videos of Mechanic In A Bottle and Ethanol Shield

GASOLINE SOLUTIONS Gas can go bad quickly! Contaminants like water, ethanol, gums and more can cause starting and operating problems. Protect and maintain your valuable investment with our solutions!

TEST for gas quality

**Mechanic In A Bottle™
2-in-1 Gasoline Quality Test**
77700-10666



QUICKLY TEST FOR BAD FUEL & WATER CONTAMINATION

- For both standard and 2-cycle mixed gasoline
- 2 Part test for stale fuel or water
- Keeps bad fuel out of equipment
- Fast, easy & inexpensive test quality and see if you have water contamination

NEW

UPGRADED gas & diesel formula

**Mechanic In A Bottle™
Gas & Diesel**



Item No.	Description
77700-13537	4 oz. (12 Pk Display Tray)
77700-13538	8 oz. (9 Pk Display Tray)

FIX AND MAINTAIN ALL GAS & DIESEL ENGINES

- Cleans injectors and the entire fuel system so that it starts efficiently and operates in top condition
- Fuel stabilizer keeps fuel fresh; protects the engine, prevents problems & helps with easy starts after storage
- Superior antioxidant and anticorrosive package
- Removes varnish, shellac, carbon deposits and disperses water in the fuel system
- Helps prevent the formation of fuel contaminants including gums, varnishes, sludge deposits, bacteria, fungus
- On machine carburetor, injector, & internal engine component cleaning
- Reconditions rubber and plastic components and rejuvenates rubber gaskets and seals
- Replaces lost lubrication, extending the life of pumps and injectors
- Helps revitalize old fuel

CHEMICALS

DIESEL SOLUTIONS Did you know that WATER is a main problem with diesel fuel? Water accumulation can lead to microbial growth (like bacteria and mold) which leads to sludge, rust, asphaltenes, plugged filters and more! STOP the water and you greatly reduce the issues!

TEST for diesel fuel quality

Diesel Mechanic In A Bottle™ 4-in-1 Fuel & Tank Contamination Test Swabs

77700-10667

- Includes 10 swabs
- Includes an extension wand that reaches to the bottom of the tank

QUICK TEST FOR FUEL QUALITY, WATER & CONTAMINATION

- Test for: bad diesel fuel (fuel oxidation), water contamination, rust & scale, sludge & asphaltenes
- Test fuel to avoid damage/repairs
- Keep contaminated fuel out of equipment
- Fast, easy & inexpensive test



FIX diesel issues; remove the water

Diesel Tank Water Extractor/Absorber

77700-10717



Keep in your storage tanks at all times. Reuse approximately 10 times or until dirty.

REMOVES WATER & RUST

- Fixes issues by removing existing water
- Removes water & salt water from storage fuel tanks
- Easy installation & removal by high strength tether line, included
- Neodymium magnets remove insoluble rust
- Treats 80 to 160 gallons of diesel fuel
- Fast, easy & inexpensive test

PREVENT fuel related issues

Ethanol Shield™ Fuel Stabilizer

Item No.	Description
77700-10660	4 oz. (12 Pk Display Tray)
77700-10661	8 oz. (9 Pk Display Tray)



FUEL STABILIZER PREVENTS FUTURE ENGINE PROBLEMS

- Stabilizes fuel up to three years
- OEM Tested, verified & used
- Prevents engine repairs & ethanol fuel problems
- Works in all 2 & 4 cycle engines
- Prevents water issues, conditions rubber & plastic
- Vapor corrosion inhibitor (VCI) protects above and below the fuel line
- No alcohol

OIL SOLUTIONS All oils, including new oils, are negatively affected by water. Bound water in oil has no lubrication. Dissolved water molecules (polar) actively seek other polar molecules, including metals, additives such as detergents, antioxidants, friction modifiers and anti-wear additives. Water will come out of suspension and form white gummy masses in areas of the unit and cannot be flushed. Solution - MIB Oil Fix & Stabilizer can FIX and PREVENT emulsified oils equipment runs and operates at maximum efficiency.

Mechanic In A Bottle™ Hydraulic Oil Fix & Stabilizer

77700-13412 1 Gallon
77700-13413 24 oz.

NEW



FIXES & PREVENTS MILKY CONTAMINATED HYDRAULIC FLUID

- Stabilizes oil/fluid
- Oil system flush
- Adds lubricity, anti-corrosive
- Neutralizes acids and encapsulates water

Diesel Exhaust Fluid (DEF)

Kubota DEF is an API certified diesel exhaust fluid made of a non-toxic solution of 67.5% purified water and 32.5% ultra pure automotive grade urea. Kubota DEF is not a fuel additive. Instead, when injected into the exhaust stream and passed over a catalyst, Kubota DEF helps convert NOx into nitrogen gas and water vapor.

- Non-toxic
- Non-flammable
- Non-polluting
- Meets ISO 22241 specifications

Item No.	Description
77700-10670	2.5 Gallon
77700-10671	55 Gallon Drum
77700-12945	330 Gallon Tote



DEF Contamination Test Strips

77700-13382 (100 Strips/Bag)

It's important to keep DEF free of contamination as it can shorten the life of or damage the SCR system. The test shows contamination such as diesel fuel, oil, gasoline and other hydrocarbons.



NEW

- Simple, low cost, easy to use
- No color change = PASS
- Darker color change = FAIL



Polar D Winter Treatment

77700-10669 **24 OZ.**

- Absorbs water
- Prevents gelling, waxing, freezing and icing
- Lowers pour point and cold filter plug point
- Increases lubricity
- Contains cetane improvers and injector cleaners
- Increases fuel economy, horsepower and torque
- Contains no alcohol or solvents
- Diesel Treatment



Diesel Power Year-Round Treatment

77700-10668 **24 OZ.**

- Totally disperses water
- Contains cetane improvers
- Contains lubricity additives
- Cleans the injection system
- Contains no alcohol or solvents
- Tier 4 engine compliant
- DPF approved



A B C D E F G

Brake & Parts Cleaner

A. 77700-05575

- Removes contaminants from metal parts, brake linings and pads, springs, cylinders and fasteners

Cleaner/Degreaser

B. 77700-05576

- Removes oil, printing inks, grease and tape residue (not available for sale in California)

Super Strength Penetrating Oil

C. 77700-05574

- Frees corroded or rusted parts and clings to frozen parts until loosened

Carb & Choke Cleaner

D. 77700-05573

- Quick acting—penetrates through oil, dirt, gum, etc. and sprays in any position

Glass Cleaner

E. 77700-05577

- Non-abrasive and contains ammonia and other cleaning power additives

Chain & Cable Lube

F. 77700-05572

- Penetrates to protect pins, bushings and inner core of wire cable with good rust protection and sprays in any position

White Litho Grease

G. 77700-06324

- Long lasting lubrication and protection that won't freeze, melt or run

CHEMICALS

Powerful Corrosion Protection & Superior Lubrication

Fluid Film is the worldwide standard for corrosion control and equipment maintenance. Its unique woolwax (lanolin) formula contains no solvents to evaporate. Always active, it will not become tacky and will not readily freeze, providing long-term protection to all metals and superior lubrication to all moving parts.



Scan the QR code to view a demo video!

Fluid Film

- A. 11 oz. Aerosol 77700-07288
- B. 1 Gallon 77700-07289
- C. 8 oz. Brush Top Can 77700-07290
- D. NEW! 5 Gallon 77700-12944

THE PERFECT SOLUTION TO RUST PREVENTION

Numerous applications including corrosion protection, lubrication and water displacement. Proven in the most severe conditions, FluidFilm stops rust on contact. It creates a non-drying barrier of protection that moisture and corrosive environments cannot penetrate.



DEPEND ON THE WORLD'S MOST TRUSTED BRAND

- Easy to apply
- Will not harm most paints, plastics, or oil-resistant rubbers
- Non-hazardous, non-toxic product that will not burn crops when used on cutting equipment, will not freeze in harsh climates or conditions and is a great water displacement product in moist conditions

Chemicals

Non-Aerosol Spot Sprayer

77700-12949

- 32 fluid ounces
- Refillable
- ECO-friendly
- Eliminates dangerous or harmful propellants
- 80-150 PSI operating pressure
- Not for use with paint products or flammable propellants
- Ideal for Fluid Film, Kubota Clean & Shine and related items



Acid-Free Grey Silicone Gasket

07935-60074

- Solvent-free and non-acid liquid gasket based on modified silicone with low odor emission
- Within a very short time it forms a rubber-like high elastic gasket completely adapted to the surface structure of the flange faces



Grey Silicone Gasket

70000-73764

- OEM specified, high viscosity silicone grey gasket maker
- Excellent oil resistance (engine oil, gear oil, transmission oil)
- For use with LLC—cures at room temperature and has rubber-like elasticity



Semi-Drying Grey Silicone Gasket

70000-74000

- A synthetic rubber, visco-elastic sealer that is semi-drying
- Applications include sealing transmission case covers, motorcycle cases, timing chain cases, side covers, 2-piece cylinders, clutch housing bolts and oil filter mounting surfaces



Liquid Gasket Sealant

77700-01822

- OEM specified, high viscosity silicone aluminum gasket maker
- Non-slumping paste with strong adhesion properties to metals and plastics; effective in vibrating conditions
- Highly resistant to oil, chemicals and coolants
- High temperature applications



Premium Tire Sealant

Kubota Premium Tire Sealant is simply the finest tire sealant in the world. Our high-quality sealant not only seals tread area punctures but also rim and bead leaks, weather cracking and porosity leaks. The tire sealant stays effective for the life of the tire!

- Seals hundreds of punctures up to 1/4" diameter
- Up to 3/4" punctures normally seal in heavy ply industrial tires
- Keeps tires properly inflated
- Keeps tires up to 35° cooler
- Makes a permanent repair
- Reduces blow-outs
- Indefinite shelf life
- Reduces lost man hours
- Extends tire casing life
- Reduces thrown re-treads
- Eliminates tire repair costs
- Increases fuel economy of vehicles
- Reduces equipment downtime
- Coats evenly, aids heavy truck tire balance
- 100% Water soluble for easy cleanout
- Meets EPA standards for municipal disposal
- Non-flammable, non-hazardous
- Will not rust, corrode, or pit wheels
- Does not void tire manufacturer warranties
- Works in tube type tires
- More effective in tubeless tires

Scan the QR code to view a demo video!



A B C D E

HOW IT WORKS

Seals punctures up to 1/4" in standard tires and up to 3/4" in heavy ply tires

Coats all inner surfaces of tire and rim to prevent all forms of air loss, including rim, bead and porosity leaks

Installs easily through the valve stem once the valve core is removed

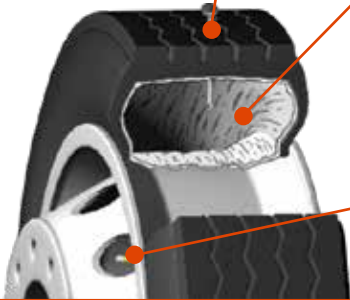

	Item No.	Description
A	77700-05583	32 oz.
B	77700-05584	1 Gallon
C	77700-05539	5 Gallon
D	77700-05585	Pump for 5 Gallon
E	77700-05586	POP Display
	77700-06115	55 Gallon Drum
	77700-06116	275 Gallon Tote

COATS EVENLY WHILE DRIVING & SEALS ALL INTERIOR SURFACES

“ I've been using Kubota Tire Sealant since Kubota started offering it. Our customers are really impressed with it & recommend it to their friends. We haven't had any complaints from anyone! Our salesmen recommend it when selling lawn mowers & for the front tires on tractors. We also use 5 gallon pails in the shop. **”**

Oscar V.
Texstar Kubota, Stephenville, TX

CHEMICALS

HighTec HLP 22 Hydraulic Fluid

77700-12946 **20 LITER / 5.3 GALLONS**

HIGHTEC HLP 22 is a multi-purpose lubricating oil with a high load-bearing capacity that improves performance in mixed-friction conditions, thus counteracting friction or frictional vibrations due to stick-slip.

- High-quality hydraulic fluid containing additives for preventing corrosion, wear, ageing and friction. Highly effective EP active agents guarantee excellent compression resistance.
- Viscosity: ISO VG 22
- Base oil: Mineral based
- The quality of this product is equivalent to EU regulations: DIN 51524, p.1 and 2 (HL, HLP) - ISO 6743/4 (HM); ISO 11158 (HM) - AFNOR NF E 48-603 (HM) - SS 155434 - VDMA 24318 - Vickers I-286-S
- Kubota factory filled OEM specified



Chemicals



Extended Life Antifreeze/Coolant

Spend more time on the job and less time taking care of unnecessary breakdowns with Kubota brand Coolant/Antifreeze. Kubota coolants, available in Concentrate formula and 50/50 Premix are engineered and approved to match Kubota engines and other high performance engines. Consumer grade automotive coolants are no match for the heavy duty protection you get when using Kubota brand Coolant/Antifreeze!

- Specially formulated and approved to work with Kubota engines and components
- Provides excellent corrosion protection, preventing corrosion of metal parts in the cooling system
- Compatible with all materials in the cooling system—resulting in corrosion protection performance and non-metal compatibility performance for long-term life and performance
- Color: green

Protect Your Engine From:

- Water pump failure
- Cavitation
- Rust and corrosion
- Hard water deposits
- Winter freeze up / summer overheating
- Gel build-up

Item No.	Description	Size	Freezing	Boiling
77700-06325	50/50 Premix	1 Gallon	-34° F	265° F
70040-0L014	100% Concentrate	1 Gallon	-34° F	265° F
NEW 77700-13454	100% Concentrate	55 Gallon	-34° F	265° F
NEW 77700-13455	50/50 Premix	55 Gallon	-34° F	265° F

Rowe HighTec Antifreeze

77700-07598

- Premium radiator antifreeze concentrate based on monoethylene glycol and free of nitrite amine and phosphate, providing superior corrosion protection
- Select model factory fill blue coolant
- Provides reliable protection against deposits and foaming, thus ensuring optimum heat removal



Dot 4 Brake Fluid

70000-13543

- Blend of premium grade glycol and glycol ethers with inhibitors for corrosion protection
- Designed for use in braking systems fitted with rubber cups and seals made from styrenebutadiene rubber (SBR), or a terpolymer of ethylene, propylene, and a diene (EPDM)

NEW





Commando Spill Containment Kit

77700-09774

- Ideal for transportation, pesticide-hauling vehicles, chemical handlers or haulers. Also ideal for mixing and storage areas.
- Absorbs up to 7 times its' own weight in liquid
- Absorbs spills 3 times faster than the leading brand and does not leave residue behind
- Fluid pickup rating is 6 gallons per kit
- Each kit includes: Qty 1 - Highly visible yellow chemical-resistant carry bag, Qty 1 - Bag of General Absorbent (77700-09776), Qty 2 - Diking tubes (3.5" x 48"), Qty 2 - Pillows (12" x 21"), Qty 2 - Temp spill disposable clean-up bags, Qty 1 - Pair 15 mil nitrile gloves, Qty 1 - Pair safety goggles, Qty 1 - Pair Tychem SL Saranex boot covers and Qty 1 - Instruction sheet



Minuteman Spill Containment Kit

77700-09775

- Ideal spill response kit for transportation, trucking and general chemical spills
- Absorbs up to 7 times its' own weight in liquid
- Absorbs spills 3 times faster than the leading brand and does not leave residue behind
- Pickup rating is 7 gallons of liquid per kit
- Each kit includes: Qty 1- Highly visible orange chemical-resistant carry bag, Qty 1 - Bag of General Absorbent (77700-09776), Qty 3 - Diking tubes (3.5" x 48"), Qty 2 - Pillows (18" x 18"), Qty 1 - Pair 15 mil nitrile gloves, Qty 1 - Pair of safety goggles, Qty 1 - Pair rubber boot/shoe covers (X-LRG), Qty 2 - Temp spill disposable clean-up bags, Qty 2 - Hazardous waste labels, Qty 2 - Non-Hazardous waste labels and Qty 1 - Instruction sheet



Shop Service Bay 30 Gallon Kit

77700-09779

- Ideal for manufacturing plants, warehouse, chemical storage, and mixing and loading areas
- Comes in a weatherproof drum
- Absorbs 7 times more liquid than the leading clay brands and does it 3 times faster
- After cleanup, drums can serve as sealed, safe storage and disposal containers for absorbed spill materials
- Each kit includes 15 Chemsorb® GA Diking Tubes, 10 Chemsorb® GA Pillows, 4 HazMat Disposal Bags, 2 Tychem SL Saranex Coveralls, 2 pair Splash Goggles, 2 pair Rubber HazMat Boots, 2 pair 15 mil Nitrile Gloves, 1 Roll Caution Tape, 4 HazMat Labels, 4 non-hazardous waste labels, 1 parts reorder form

SPILL CONTAINMENT

General Absorbent Service & Parts Spill Containment

- Chemsorb® GA (General Absorbent) is the leading lightweight, fast-acting absorbent formulated to quickly clean up any liquid or semi-solid spill
- Based on all natural perlite, this product is enhanced with a proprietary de-dusting technology which facilitates ease of use and fast absorption
- Absorbs 7 times more liquid than the leading clay brands and does it 3x faster
- When swept up, the floor is left clean and dry, providing a cleaner environment
- Meets all OSHA and EPA standards, it is silica-free and USDA and NSF approved for use in food processing facilities
- Proudly made in USA

Item No.	Description
77700-09776	3 lb
77700-09777	10 lb
77700-09778	Service & Parts Spill Containment 60 lb Drum



Chemicals



Chemsorb® Universal Absorbent Pads 77700-11845

- 15" x 18", 100 pads
- Dimpled pattern will quickly soak up liquid
- Lightweight sorbents pads provide the users with a durable absorbent for cleaning up petroleum-based spills and leaks effectively
- Absorbency per pack: 21 gallons
- Even when fully saturated, it will keep its shape



Chemsorb® Oil Only Absorbent Pads 77700-10734

- 15" x 18" — 50 per box
- Absorbs the oil and leaves the water behind
- Hydrocarbon-based fluids stick to the fibers while repelling water
- Meltblown sorbent pads made from a single layer of strong, uniform polypropylene fibers
- Formulated to quickly clean up hydrocarbon liquids including: oil, gasoline, diesel fuel, aviation fuel, petroleum, kerosene, motor oils and transmission oils
- Incinerates to less than two percent ash, will not mildew and will float indefinitely



Chemsorb General Absorbent Woven Diking Tubes 77700-10736

- Surround the most aggressive spill with our rugged 3.5" x 48" diking tubes that absorbs oil, fuel, water, coolants and more
- Designed to be rugged and durable enough to survive real-world applications including: spills, leaks, discharges, drips and leaching
- Pulls the liquid into its' core and traps it, leaving a dry and residue-free surface
- 4 Pack

Chemsorb® Heavy Duty Absorbent Barrel Top Pads 77700-10735

- The 22" diameter universal drum toppers will fit standard 55-gallon drums and stop liquids from reaching the floor
- Universally absorbs all liquids, trapping them inside the dimpled structure
- Rapidly soaks up all liquids, both oil-based and water-based
- Packed 10 per box



1.5" Adjustable Wheel Bonnet Straps

77700-12159

- Safety release ratchet
- Snap hooks
- Long strap with D-ring end
- 5500 lb. break strength
- Includes: 1 ratchet with snap hook, 1 strap with snap hook end, 1 long strap with D-ring end, 1 cross strap with adjustment loops



10' x 1" Camo Ratchet with S Hooks

77700-12133

- Coated S hooks
- All black metal parts
- Built in hook loops
- Camo webbing
- Camo handle grip
- 1500 lb. break strength



ShockStrap® Load-Absorbing Ratchet Straps

- **Dependable** - a ShockStrap provides superior shock absorption without coming loose—keeps tension on the strap
- **Safety Strap** - a backup strap in case the ShockStrap is compromised
- **Durable** - made from our proprietary formula that is not affected by most chemicals, sunlight, oil, salt water, fungus or moisture
- **Rust Resistant** - hooks and buckle are yellow zinc coated, which lasts 8 to 10 times longer than chrome plating
- **Soft Loop** - flexibility to always find a way to secure your load
- **2 - Pack Card** - with informative text and product images

Item No.	L x W	Break Strength	Work Load
77700-10680	9' x 2"	6,000 lbs.	2,000 lbs.
77700-10681	18' x 2"	6,000 lbs.	2,000 lbs.



Scan the QR code to view a demo video!

TIE DOWNS

Cargo Straps

- Thermoplastic rubber handles molded onto frames
- Weather resistant and corrosion resistant hardware finished with zinc and nickel plating or powder coating
- Cut and abrasion resistant webbing is woven from high tensile strength polyester that performs better than nylon



77700-03176



77700-03177

Heavy Duty Ratchet Tie Downs

Item No.	L x W	Hook Style	Handle Style	Break Strength	Work Load
77700-03176 (2 pk)	27' x 2"	JJ Hook	Bar Handle	10,000 lbs.	3,300 lbs.
77700-03177 (2 pk)	27' x 2"	Flat Hook	Bar Handle	10,000 lbs.	3,300 lbs.



77700-03169



77700-03175



77700-03178

Standard Duty Ratchet Tie Downs

Item No.	L x W	Hook Style	Handle Style	Break Strength	Work Load
77700-03169 (ea)	16' x 1"	S Hook	Small Bar Handle	1,500 lbs.	500 lbs.
77700-03175 (ea)	16' x 1.5"	JJ Hook	Sure Grip Handle	5,000 lbs.	1,666 lbs.
77700-03178 (2 pk)	6' x 1"	S Hook	Small Bar Handle	1,800 lbs.	600 lbs.



Cargo Control

8' x 3/8" XRT Rope Lock Tie Down

77700-12132

- Push button release
- Scratch-resistant coated hooks
- 3/8" diameter rope (9.5mm)
- 500 lb. load limit



Scan the QR code to view a demo video!



Adjustable Tarp Straps

- 36" Overall length
- Integrated nylon hooks
- 6 Pre-molded holes along the strap for on-the-go adjustments
- Made of FlexaPURE[®], contains no rubber or latex
- UV-, chemical-, fuel- and oil-resistant
- Salt and fresh waterproof
- All weather, all year
- Limited lifetime warranty
- Made in the USA



Item No.	Length	Color
77700-03656	24"	Black
77700-12134	36"	Orange
77700-03658	36"	Black

Heavy Duty Tarp Straps

- The 24" tarp strap features patented molded stirrup holes for adjustable length
- Weather and crack resistant natural rubber
- Versatile strap with high elasticity holding power
- Outlasts standard straps by over 30%

Item No.	Length	Color
77700-03653	9"	Black
77700-03654	15"	Black
77700-03655	21"	Black
77700-03657	31"	Black
77700-03659	41"	Black



Heavy Duty-Adjustable (24")

Heavy Duty-Standard



Tarp Strap S-Hooks

77700-03660

- Four pack replacement hooks
- 5 mm S-hooks for tarp straps and adjustable tarp straps
- Strong and durable zinc coated finish

Recovery Rope

77700-13410

- 100% double braided nylon rope
- 6" eye loops with protective nylon sleeves to minimize abrasion
- Rope stretches up to 30% of its original length and "slingshots" the stuck vehicle
- 45% stronger and lighter than wire rope winch line
- Safer than wire rope or chains if the line breaks
- 7300 lbs. breaking strength
- 1/2" x 20'



NEW

Soft Shackle for Recovery Rope

77700-13411

- Made of Ultra High Molecular Weight Polyethylene (UHMWP)
- Effective way to quickly hook onto a vehicle and carry large loads.
- Dries quickly - fibers do not absorb water.
- 33000 lbs. breaking strength
- Length: 22-3/4"
- Diameter: 7/16"

NEW



CARGO CONTROL

Cargo Control Kit

77700-12957

- Convenient kit includes all the essentials you need to help you secure and keep your cargo safe and damage-free, from gloves to straps
- Workload capacity 6,000 lbs
- Powder-coated and nylon parts prevent damage to your vehicle
- Adjustable equipment will allow you to confidently secure big and small loads
- Straps designed to provide tension to properly secure and stabilize cargo
- Quick release straps make it easy to unload
- Heavy duty storage bag



Cargo Net

77700-08978

- 34" x 34" — stretches to 60" x 60"
- Heavy duty plastic hooks prevent scratching
- Finger holes in hooks for safety and easy hook up
- Weather resistant
- Secures odd, bulky shapes
- Adjustable hooks
- Fits most UTV/RTV Bed Boxes

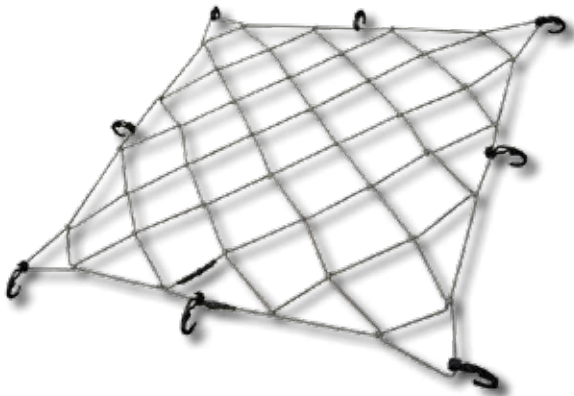

D-Rings

- Easy bolt on installation

Item No.	Description	Capacity
77700-08979 (4 pk)	Light Duty Surface Mount	1,200 lbs.
77700-08980	Medium Duty Surface Mount	5,000 lbs.
77700-08981	Weld On	15,000 lbs.
77700-08982	Weld On	20,000 lbs.



Cable Ties

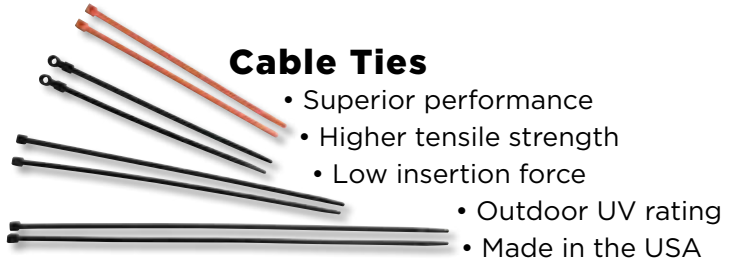

- Superior performance
- Higher tensile strength
- Low insertion force
- Outdoor UV rating
- Made in the USA

Item No.	Length	Rating	Qty/bag	Color
77700-08983	7.6"	50 lb. / 222.5 Newton	100	Black
77700-08984	11.1"	50 lb. / 222.5 Newton	100	Black
77700-08985	14.6"	50 lb. / 222.5 Newton	100	Black
77700-08986	15"	120 lb. / 533.7 Newton	100	Black
77700-08987 (Mount Head)	8"	50 lb. / 222.5 Newton	100	Black
77700-08988	24"	175 lb. / 778.4 Newton	50	Black
77700-08989	7.6"	50 lb. / 222.5 Newton	100	Orange

RTV Tow Strap

77700-08977

- 1-1/4" X 12' tow strap with loops and shackle
- 5,000 lbs. break strength
- Forged shackle
- Reinforced attachment loops



Trailer Safety Chains

- Used as a backup system in the event a trailer separates from the ball or hitch
- Assist in bringing the trailer to a stop
- The Gross Vehicle Weight Rating (GVWR) of the trailer helps determine which chains need to be used
- Two chains are required and each individual chain must meet or exceed the total strength equal to the GVWR of the trailer, not the two chains combined
- These chains give you a wide selection for use with the most popular trailer sizes used by your customers

Item No.	Description	GVWR
77700-09733	8/0 Straight Cross x 30 in 17/32 Trailer S Hook with Wire Latch one end Bright Zinc 2 pc/Ctn	7,600 lbs.
77700-09734	3/8 G43 x 35 in Clevis Slip Hook with Latch one end Bright Zinc 2 pc/Ctn	16,200 lbs.
77700-09735	3/8 G70 x 36 in Clevis Slip Hook with Latch one end Heat Treated Gold Chromate 2 pc/Ctn	26,400 lbs.



Ag Safety Chains

- With the unique easy latch hook, these safety chains are perfect for the aftermarket
- They replace the OE chain with an easy to use latching mechanism and meet all ASABE standards for towed equipment
- Whether replacing an old chain or attaching on a piece of refurbished equipment, these chains get the job done

Item No.	Description	Safety Rating
77700-09736	10,000 lb Ag Safety Assembly x 61 in Gold Chromart	10,000 lbs.
77700-09737	20,000 lb AG Safety Assembly x 62 in Gold Chromart	20,000 lbs.



RTV-All Terrain Tire Chain

- Heavy duty, twist link cross chain built to NACM specifications
- Two link spacing cross chains for additional traction
- Shipped in pairs

Tire Sizes				Weight Per Pair	Import Item No.
24 x 9 x 11	24 x 11 x 9	24 x 11 x 10	24 x 11 x 11	38	77700-06317
24 x 11 x 12	25 x 8 x 12	25 x 10 x 11	25 x 10 x 12		
25 x 11 x 9	25 x 11 x 12	26 x 9 x 12	26 x 9 x 14		
26 x 10 x 12	26 x 10 x 14				

TIRE CHAINS

RTV/Tractor Turf Tire Chains

Get maximum traction in ice or mud by using Kubota RTV Tire Chains—typically a gauge or two heavier on cross chain wire diameter compared to competing models. Better traction, more durable and lasts longer than the competition tire chains.

- Heavy duty case hardened .234" cross chains
- The .234" wire size is the NACM spec for a lot of light truck sizes, so it's more than adequate for ATV/UTV use
- Cross links that are constructed with reinforced v-bar for extra off-road bite and extended wear
- All sizes feature two link spaced cross chains—twice the amount of cross chains vs. standard tire chain sets
- Provides extra traction and smoother ride
- Shipped in pairs



Kubota RTV	Tire Size	Item No.
RTV400 / RTV500	24 x 9-12 ATV	77700-07841
	24 x 9-12 HDWS	(ATV, HDWS)
	24 x 11-12 HDWS	77700-06317
	24 x 11-12 ATV	(ATV, HDWS)
RTV-X900 RTV-X1100 RTV-X1120 RTV-X1140 RTV-XG850	25 x 10-12 ATV	77700-06317
	25 x 10-12 HDWS	(ATV, HDWS)
	25 x 12-12 TURF	77700-07843
	25 x 11-12 ATV	(TURF)

Alpha Trax Tire Chains

Handle the snow and ice with the next generation traction device!

- For light trucks and SUV's
- Superior alternative to cable products
- Easy installation - rubber adjusters included
- Supports sustained use on snow, ice and bare roads
- Meets SAE Class S wheel well clearance requirements



Tire Sizes						Weight Per Pair	Import Item No.		
P235/75R15	215/85R16LT	29X9.5-16	235/65R17	235/60R18	255/45R19	5	77700-12928		
235/70R15LT	225/75R16LT	8.75-16.5LT	205/75R17.5	245/55R18	275/40ZR19				
245/70R15LT	235/65R16LT	P215/70R17	215/70R17.5	265/45R18	245/45R20				
245/75R15LT	235/70R16LT	P225/70R17	215/75R17.5	225/55R19	255/45R20				
275/60R15LT	245/65R16	P245/60R17	225/55R18	235/50R19	265/40R20				
29X9.50-15	255/60R16	P255/55R17	225/60R18	235/55R19					
215/80R16LT	265/60R16LT	225/75R17LT	235/55R18	245/50R19					
P255/70R15	255/65R16LT	P245/65R17	235/70R17.5	285/45R18	235/55R20			6	77700-12929
245/85R15LT	255/70R16LT	P255/65R17	P295/45R18	285/50R18	245/50R20				
255/75R15LT	265/65R16	215/80R17	225/65R18	225/60R19	255/50R20				
265/70R15LT	285/60R16LT	245/70R17LT	225/70R18	245/55R19	265/45R20				
30X9.50-15LT	9.50-16.5LT	255/60R17	235/65R18	255/50R19	275/40R20				
225/85R16LT	10-16.5LT	265/55R17	245/60R18	255/55R19	295/40R20				
235/75R16LT	30X9.5-16.5	265/60R17	255/55R18	275/50R19	265/45R21				
245/70R16LT	P235/70R17	275/50R17	265/55R18	285/45R19	265/45R22				
245/75R16LT	P235/75R17	225/75R17.5	275/45R18	225/55R20					
265/75R15LT	235/85R16LT	P265/65R17	235/75R17.5	275/55R18	285/45R20	6	77700-12930		
31X9.50R15	265/70R16LT	P275/60R17	245/70R17.5	265/50R19	305/45R20				
31X10.5-15LT	275/60R16LT	225/80R17	245/75R17.5	275/45R19	285/45R21				
32X9.5-15	275/65R16LT	235/85R17	P265/60R18	245/60R20	245/45R22				
7.50-16LT	295/65R16	245/75R17LT	235/70R18	275/45R20	285/40R22				
235/80R16	31X10.5-16.5LT	275/55R17	255/60R18	285/40R20					
275/75R15	255/75R16LT	235/80R17	255/65R18	8-19.5	275/50R20			6	77700-12931
285/70R15	265/75R16LT	265/70R17LT	255/70R18	215/75R19.5	295/45R20				
285/75R15	265/80R16LT	275/65R17	285/55R18	225/70R19.5	255/50R21				
325/60R15	275/70R16LT	285/60R17	305/55R18	225/75R19.5	275/45R21				
31X11.5-15LT	275/75R16	285/65R17	P255/60R19	235/70R19.5	295/40R21				
32X11.5-15LT	285/65R16	P265/65R18	255/65R19	225/75R20	275/45R22				
33X10.5X15	31X11.5-16.5	P275/60R18	275/55R19	255/55R20					
245/85R16LT	P255/70R17	245/70R18	285/55R19	265/50R20					
295/70R15	315/70R16	305/65R17	285/60R18	265/60R20	285/45R22	6	77700-12932		
33X9.50-15LT	12-16.5LT	345/55R17	285/65R18	275/55R20	305/40R22				
255/85R16LT	P255/75R17	245/75R18	295/60R18	275/60R20	305/40R23				
285/70R16LT	265/75R17	265/70R18	245/70R19.5	295/50R20					
285/75R16LT	275/70R17	275/65R18	P285/50R20	325/50R20					

Chains

Duo GripTractor Chains

- Features H-pattern cross chains which keep the chain on top of the tire
- Heavy duty 3/8" case hardened cross chain
- For off-road use only
- Shipped in pairs



Roadmaster Tractor Chains

- Suitable for off-road or over-the-road use
- Built to NACM specifications
- Shipped in pairs



Tire Sizes					Weight Per Pair	Domestic Item No.	Import Item No.
9.5-24	9.5-28	11.2-24			110	77700-99830	77700-99853
9.5-32	11.2-28	230/95R32	355/80R20		124	77700-99831	77700-99854
10.5/80-18	12-16.5	280/70R20	300/70R20	315/75D15	88	77700-99832	77700-99855
12.4-24					130	77700-99833	77700-99856
9.5-36	9.5-38	11.2-32	12.4-28		143	77700-99834	77700-99857
13.9-36	320/85R34				150	77700-99835	77700-99858
13.6-24	13.6-26	14.9-24			141	77700-99836	77700-99859
14.9-26					156	77700-99837	77700-99860
14.9-28	14.9-30				173	77700-99838	77700-99861
13.6-28	16.9-24	320/85R38	340/85R28	380/85R34	160	77700-99839	77700-99862
14.9-38	15.5-38	320/90R46			194	77700-99840	77700-99863
17.5-24	17.5L-24				135	77700-99841	77700-99864
16.9-26	16.9-28	420/85R28			169	77700-99842	77700-99865
16.9-32					184	77700-99843	77700-99866
16.9-34	230/95R44				200	77700-99844	77700-99867
18.4-16.1	21.5L-16.1				132	77700-99845	77700-99868
18.4-24	19.5L-24				171	77700-99846	77700-99869
16.9-30	18.4-26	18.4-28	18.4-30	540/65R30	188	77700-99847	77700-99870
550/65R25	600/65R28						
18.4-34	480/85R34	600/65R25			206	77700-99848	77700-99871
16.9-38	18.4-38	20.8-34	380/90R50	420/80R46	226	77700-99849	77700-99872
460/85R34	480/80R38						
18.4-42	18.4-46	380/90R54	480/80R46		221	77700-99850	77700-99873
20.8-38					259	77700-99851	77700-99874
24.5-32	23.1-34	28.1-34	620/70R42	650/75R32	252	77700-99852	77700-99875

Tire Sizes					Weight Per Pair	Domestic Item No.	Import Item No.
9.5-16	10-16.5	260/70R16			53	77700-99876	77700-99897
8.3-24	10.5/80-18	12-16.5	280/70R20	300/70R20	62	77700-99877	77700-99898
315/75D15							
7.2-24	9.5-24	12.5/80-18			70	77700-99878	77700-99899
9.5-28	11.2-24	15-19.5	340/80R18	355/80R20	82	77700-99879	77700-99900
360/70R20	380/70R20						
41x14.00-20	320/70R24				91	77700-99880	77700-99901
9.5-32	11.2-28	12.4-24	12.4-28	230/95R32	95	77700-99881	77700-99902
320/85R24							
230/95R36					105	77700-99882	77700-99903
13.6-16	14-17.5				76	77700-99883	77700-99904
13.6-24	13.6-26	380/70R24			106	77700-99884	77700-99905
13.6-28	14.9-24	360/70R28			105	77700-99885	77700-99906
14.9-26	14.9-28				120	77700-99886	77700-99907
16.9-24	17.5-24	17.5L-24	320/85R38		123	77700-99887	77700-99908
14.9-30	16.9-26	16.9-28	420/85R28		130	77700-99888	77700-99909
380/85R34					142	77700-99889	77700-99910
15.5-38	16.9-34				150	77700-99890	77700-99911
18.4-24	18.4-26	19.5L-24			167	77700-99891	77700-99912
18.4-28	540/65R30	550/65R25			181	77700-99892	77700-99913
16.9-30	18.4-30	21L-24			191	77700-99893	77700-99914
18.4-34	600/65R25				205	77700-99894	77700-99915
18.4-38					217	77700-99895	77700-99916
14.9-46	18.4-42	420/80R46			250	77700-99896	77700-99917

Alloy Skid Steer Tire Chains

- Heavy duty tire chains have been engineered specifically for use on Skid Steers in harsh conditions
- Provide excellent traction in both snow and mud and are built for durability
- 8mm square link alloy cross chains, shipped in pairs
- Wear bars on cross links for added durability and traction



Item No.	Tire Size	Weight Per Pair	Pair Per Drum/Crate
77700-09739	10-16.5	92 lbs.	1 / Drum
77700-09740	12-16.5	114 lbs. ea	1 / Crate
77700-09741	14-17.5	134 lbs. ea	1 / Crate

TIRE CHAINS

Grader and Equipment Chains

- Designed for plows, graders and loaders
- Heavy duty, twist link cross chain built to NACM specifications
- Shipped in pairs



Tire Sizes					Weight Per Pair	Domestic Item No.	Import Item No.
13.00-24	13.00-25	14.00-20	14.00-21	15.5-25	107	77700-99918	77700-99926
14.00-24	14.00-25				123	77700-99919	77700-99927
16.00-20	16.00-21	17.5-25			166	77700-99920	77700-99928
16.00-24	16.00-25				189	77700-99921	77700-99929
20.5-25					202	77700-99922	77700-99930
18.00-24	18.00-25	18.00-26			211	77700-99923	77700-99931
23.5-25					365	77700-99924	77700-99932
26.5-25	30.5R32	710/70R38	755/70R25	800/65R32	447	77700-99925	77700-99933

Lawn Tractor Tire Chains

- Shipped in pairs



Kubota	Tire Size	Item No.
T2380 Lawn Tractor	22 x 11 x 10 Turf Tire	77700-07842

Garden Tractor Chains— 2 Link Spacing

- Constructed with double the cross chain for extra traction and durability
- Shipped in pairs



Tire Sizes				Weight Per Pair	Import Item No.
10/10.5 X 2.75	10.25 X 3.25	10 X 3.50		3	77700-99934
12 X 3				4	77700-99935
4.10/3.50 X 4	3.40/3.00 X 5			3	77700-99936
4.10/3.50 X 5	4.10/3.50 X 6	12 X 3.50 X 6	12.25 X 3.50 X 6	4	77700-99937
5.30/4.50 X 6				7	77700-99938
13 X 5 X 6				6	77700-99939
4.00/4.80 X 8				11	77700-99940
5.00/5.70 X 8				16	77700-99941
16 X 6.50 X 8	15 X 6.00 X 6			12	77700-99942
18 X 6.50 X 8				14	77700-99943
18 X 8.50 X 8				15	77700-99944
18 X 9.50 X 8				16	77700-99945
20 X 10 X 8	20 X 10 X 10			20	77700-99946
20 X 8.00 X 10	20 X 8 X 8			19	77700-99947
6 X 12	23 X 7.50 X 12			19	77700-99948
8 X 12	23 X 8.50 X 12			22	77700-99949
12 X 12	26 X 12 X 12	27 X 12 X 12		30	77700-99950
23 X 9.50 X 12	23 X 10.50 X 12			25	77700-99951
24 X 12 X 12				25	77700-99952
8 X 15	25 X 8.5 X 14	27 X 8.50 X 15		28	77700-99953
29 X 12 X 15				64	77700-99954
12.4-16	31 X 15.5 X 15	33 X 12.5 X 15		109	77700-99955
8 X 16				33	77700-99956
22 X 11 X 10				20	77700-07842

Chains



G70 Transport Tow Chains

- Preferred choice for load binding applications
- DOT approved for most applications
- Easily recognized gold finish
- Never exceed working load limits

Item No.	Chain Size	Length	Working Load Limit	Pieces per Drum	Misc. Info.
77700-99958	1/4"	14'	3,150 lbs.	10	Made in USA
77700-99959	5/16"	20'	4,700 lbs.	25	
77700-99960		20'		10	
77700-99961		16'		25	
77700-99962		16'		10	
77700-99963		14'		25	
77700-99964		14'		15	
77700-08618		10'		50	
77700-99965		3/8"		20'	
77700-99966	20'		10		
77700-99967	16'		25		
77700-99968	16'		10		
77700-99969	14'		25		
77700-99970	14'		10		
77700-08619	10'		40		
77700-07846	1/2"	20'	11,300 lbs.	10	Imported— Available in October 2022
77700-07847		20'		5	
77700-12933	5/16"	20'	4,700 lbs.	25	
77700-12935		16'		25	
77700-12934		14'		25	
77700-12936	3/8"	20'	6,600 lbs.	20	
77700-12938		16'		25	
77700-12937		14'		25	



G70 Bulk Chain & Hooks

- Transport chain with a higher strength to weight ratio
- Electronically welded and heat treated for stronger chain
- Easily recognized gold finish

Item No.	Chain Size	Length	Working Load Limit
77700-99978	1/4"	135'	3,150 lbs.
77700-99979	5/16"	275'	4,700 lbs.
77700-99980	3/8"	200'	6,600 lbs.



G43 High Test Tow Chains

- Low carbon steel ideal for most tie down applications
- Never exceed working load limits

Item No.	Chain Size	Length	Working Load Limit	Pcs/Drum
77700-99971	3/8"	20'	5,400 lbs.	20
77700-99972		14'		25

HOOKS & LOAD BINDERS

G80 T-Grab Hook

- T Hooks are specifically made to be inserted into slots in the trailer or equipment being tied down
- They are rated to match the size tow chain being used as the tie down



Item No.	Chain Size	Working Load Limit	Pieces per Carton
77700-09738	3/8"	7,100 lbs.	4

G70 Weld-On Grab Hook



- These hooks are rated for Grade 70 Chain, 5/16" or 3/8"
- For use in pulling, towing, or dragging heavy objects, not to exceed the rated capacity of the bucket or equipment being used or the hook
- Designed for use with chain, can also be used with a rope or tow strap
- Not to be used for overhead lifting

Item No.	Chain Size	Working Load Limit	Pieces per Carton
77700-07844	5/16"	4,700 lbs.	4
77700-07845	3/8"	6,600 lbs.	4

G70 Hooks

Item No.	Chain Size	Working Load Limit	Pieces Per Carton	Weight Per Carton
77700-99981	1/4"	3,150 lbs.	10	5 lbs.
77700-99982	5/16"	4,700 lbs.	10	8 lbs.
77700-99983	3/8"	6,600 lbs.	10	14 lbs.



Lever Binders

Item No.	Chain Rating (size/grade)	Working Load Limit	Weight
77700-99973	5/16" (G7)-3/8" (G4)	5,400 lbs.	7.5 lbs.
77700-99974	3/8" (G7)-1/2" (G4)	9,200 lbs.	13 lbs.



Ratchet Binders

Item No.	Chain Rating (size/grade)	Working Load Limit	Weight
77700-99975	3/8" (G7)-1/2" (G4)	9,200 lbs.	13.5 lbs.
77700-99976	5/16" (G7)-3/8" (G4)	5,400 lbs.	12.5 lbs.
77700-99977	1/4" (G7)	3,150 lbs.	3.5 lbs.
77700-07848	1/2" (G7)-5/8" (G4)	13,000 lbs.	16 lbs.



Tow Chain/Load Binder Display and Sign

77700-99957



Heavy Duty Mower & ATV Lift

77700-12962

- Designed to lift any riding mower, lawn tractor or zero-turn mowers
- Ideal for blade sharpening, belt replacement, and debris removal
- Safer and more convenient than car ramps or blocks
- The screw jack and safety-lock pin system prevents the machine from slipping or becoming unstable while performing repair and maintenance
- Can be raised with a drill and can be folded flat for storage
- Lifting capacity: 750 lbs (lifting front end only, not total weight of mower)
- Lifting height: 25"
- Wheel span measurement: 31.5" - 62.5" outside front wheel measurement

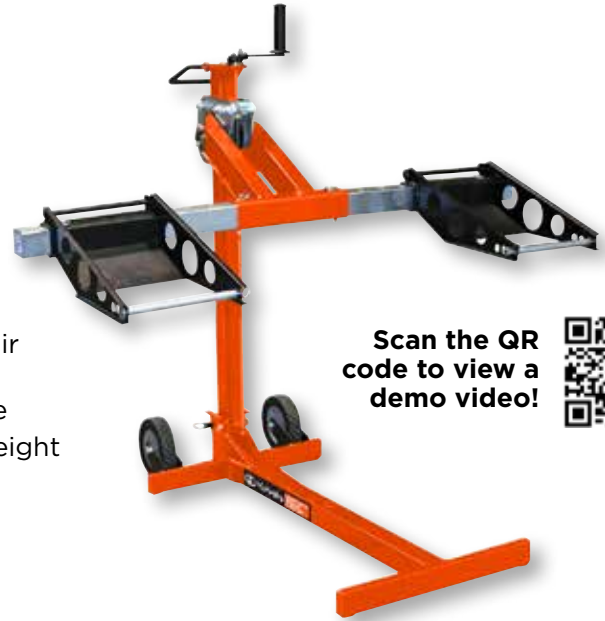

Scan the QR code to view a demo video!



Bottle Jacks

- Offers the easiest accessible pumping system
- Unique cross-type forged release valve assures positive control
- Patented built-in by-pass device protects hydraulic system from over pumping damage



10 Ton Jack Stand

77700-03506

- Medium lift pin-style jack stand
- Base size: 16" x 16"
- Min. height: 18-5/8" / Max. height: 30-1/2"

Item No.	Capacity	Base Size (L x W)	Min. Height	Max. Height
77700-13402	4 Ton	4-3/4" x 4-3/4"	7-7/16"	14-13/16"
77700-03503	12 Ton	7" x 4-1/2"	9-1/16"	18-5/16"
77700-13403	20 Ton	6-3/4" x 7-1/8"	9-7/16"	17-11/16"

Magic Lift Service Jacks

- Offers quicker lift for professional performance
- Heavy gauge, steel construction helps prevent distortion and twisting
- Patented built-in by-pass device protects hydraulic system from over pumping damage

Item No.	Capacity	Jack Size (L x W x H)	Min./Max Height	Saddle Diameter
77700-13404	3 Ton	29-1/8" x 15-3/8" x 7-7/8"	5-1/4" / 18-1/4"	4-3/16"
77700-03671	10 Ton	55-7/8" x 19-5/8" x 9-5/8"	6-7/8" / 27"	6-1/2"

77700-13404



PORTABLE WORKLIGHTS

Rechargeable Folding Worklight

77700-13396

NEW

- Features 2 LED light heads - can be used separately or together for maximum illumination
- Provides high quality and uniform lighting up to 1000 lumens
- Durable, 360° swivel handle also functions as a convenient stand
- Handle includes strong holding magnetic edge
- 3.7V 5000 mAh battery can be used as power bank



NEW

AC Powered Foldable Worklight - 4,000 Lumens

77700-13397

- This LED light can produce up to 4000 lumens of brightness
- This portable worklight features 2 brightness modes
- Unique 3-head design features two adjustable side lights with vertical and horizontal rotation, center light can be adjusted with vertical rotation
- Includes 15' power cord
- Convenient and rugged, free-standing base



270° Swiveling Worklight with Magnetic Base

77700-12950

- Multiple working modes - high intensity, low intensity & SOS flashing
- Six LED's of 3 watts each, total of 1000 lumens
- IP 65 Rated - protecting against dust and effects of low pressure water jets from any direction
- Corrosion resistant aluminum die cast construction in premium powder coated finish
- Includes 3.7V 6600 mAh battery

Heavy Duty LED Magnetic Worklight

77700-09772

- Dual color light - white & amber
- Three LED's of 3 watts each, total of 500 lumens
- 5 Volt USB charging cable
- IP 65 Rating
- Includes 3.7V 6600 mAh battery



Lift Equipment & Portable Worklights

Underhood Light with Magnetic Ends

77700-12953



- Slim & compact 10W COB underhood light, shines brighter & lasts longer
- Single button, user controlled light output (400-1,000 lumen)
- Sturdy Construction - Impact resistant ABS body built to withstand the toughest environments and 360° swiveling hooks resist wear and provide a scratch-proof grip
- Hands Free Operation - Strong magnets on both ends for easy attachment on any metallic surface leaving both hands free
- Charging of Battery - Type-C fast charging protected by rubberized bezel
- Includes 7.4V 2600 mAh battery

Waterproof Spotlight

77700-12954

- 7W LED handheld worklight featuring 700 Lumens
- Multiple working modes - high intensity, low intensity, SOS flashing, & red flashing
- IP 67 Rated
- Designed to float - Shock-proof & lightweight ABS body, rubber head & ergonomic TPR grip
- Charging of Battery - Dual charging via AC supply and 12V accessory outlet
- Includes 3.7V 2200mAh battery



PORTABLE WORKLIGHTS & FLASHLIGHT



Headlamp – Wide Beam Floodlight & Spotlight

77700-12839

- 350 Lumens - 230° Coverage
- Multiple-mode COB Floodlight and LED Spotlight up to 150'
- Built-in sensor for hands-free use
- Durable comfort stretch headband
- USB-C fast charging protected by a rubber bezel



LED Flex-Flashlight

77700-08995

- Strong holding magnet and foldable hook for hands-free use
- Convenient pocket size
- 200 lumen ultra bright COB technology
- Adjustable to 180 degree angle
- Durable molded frame resists shock, water/weather resistant



LED Pocket Pen Flashlight

77700-06342

- Generates 90 lumens of light
- 1 watt LED bulb
- Convenient pocket clip and durable aluminum chassis
- Includes 2 AAA batteries
- Dimensions: 1/2" diameter, 5.5" length
- Shock proof and drop test resistant

Slim Worklight 360° Swivel

77700-12951

- Super slim worklight for tight, cluttered and difficult to reach workspaces
- Adjust light intensity from 0-600 lumen by rotating knob
- **Integrated** - 6W COB worklight and 1W top torch
- **Sturdy Construction** - Protected against dust and effects of water spray from any direction and impact-proof ABS body
- Sturdy polycarbonate lens to withstand the toughest of job site conditions



Worklight: UV & Dual Charging

77700-12952

- Multifunction, powerful worklight & UV spotlight in one
- **Integrated** - 10W COB worklight and 3W UV light
- **Sturdy Construction** - Impact proof ABS body with rubber coating and nylon hook with 360° rotating action
- **Power-Up** - Convenient docking station for fast recharging
- **Hands Free Operation** - Strong magnet on the base to mount light onto any metallic surface for hands free use



Multi-Functional Rechargeable Flashlight

77700-10784

- Powerful 600 lumens, brightness can be adjusted
- Built-in USB charger
- Features magnets on clip and base
- Hands-free with 360° rotating hook and 180° swivel stand
- LED display shows percentage of battery remaining
- Water and dust proof rating IP44



Anaconda Wrap

NEW

77700-13391

- Easy installation - no tools required
- Diameter: 1-1/4"
- Length 10 ft



Constrictor Wrap

NEW

77700-13392

- Constrictor Wrap bundles and contains hoses, wires, cables, and cords
- Ideal for farm, home, office or business
- Easy installation - no tools required
- Diameter: 5/8"
- Length 20 ft



Hose Tamer Wrap

NEW

77700-13393

- Hose Tamer is the answer to messy and unruly hoses.
- Can stretch to fit up to 12 hoses
- Each Hose Tamer is lasered with a number to help identify hose bundles, groups or pairs more easily
- Withstands temperatures from -60° F to 212° F
- Durable polyethylene won't crack or fade as the color is part of the molding process
- Not affected by grease, oil or dirt, clean-up with any solvent or soap
- No tools required, easily changed to suit the operator
- Diameter: 1-1/2"
- Length 18"



NEW



Hydraulic Wrap Hose Markers

77700-13394

- Ideal hose tag identification system for use on farm/ag equipment
- A & B lasered into the wrap to give left and right, or above and below indicators, and they are different lengths to provide additional visual aid
- Can withstand temperatures to -60° F to 212° F
- Durable polyethylene won't crack or fade as the color is part of the molding process
- Not affected by grease, oil or dirt, clean-up with any solvent or soap.
- No tools required, easily changed to suit the operator.
- Each package contains (8) Hydraulic Hose Markers, for remotes 1 to 4 (green, blue, brown and black).
- Fits diameters 1/4" to 1-1/2"



Python Wrap

NEW

77700-13395

- Conveniently bundles and contains hoses, wires, cables and cords
- Easy installation, no tools required
- Diameter: 13/16"
- Length 15 ft



SHOP PRODUCTS



Refill

Mountable Shop Towel Bucket

77700-02460

Refill 77700-03672

- Exclusive optional dispenser mount
- Easily carried for remote use and can also be placed into the wall mount for both local usage and storage
- 200 count, 10" x 13" each (180 sq. ft. total)
- Refill features water resistant packaging with peel and reseal top and cardboard dispensing disk

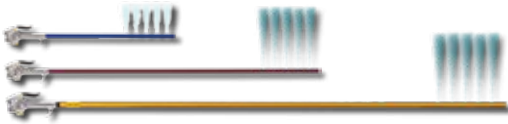

Air Comb® Filter and Radiator Cleaners

12" 77700-06205

24" 77700-03394

36" 77700-03395

- Flush 90° multi-port air flow
- Delivers 5X the air volume
- 1/4" NPT air inlet
- Access hard-to-reach areas
- Fits between radiator and condenser
- Safe on all air filters



Five ports deliver efficient air flow

Air Bender™ Blow Gun

- An intuitive and safe design for reaching hard-to-access areas with a focused, high-pressure, 90° angle output
- Allows blow back to be away from your face
- Ideal for blowing out channels, ports, or reaching around obstructions
- Tube material: Anodized Aluminum



Blue Shop Towels 6 Pack

77700-13489

- Helps hide grease and grime better than white towels allowing for longer use
- Made with 40 percent post consumer recycled fibers
- Meets the EPA comprehensive procurement guidelines and also provide opportunities to earn credits in several LEED-EB (Existing Building) operation and maintenance categories
- Ideal for general shop or industrial applications
- Made in the USA

NEW



36" Heavy Duty Grabber Tool

77700-09780

- Ergonomic handle with safety lock
- Steel frame with ABS reinforced material
- Adjustable jaw width & strong holding ABS teeth
- Removable suction cups allow for use with smooth or hard surface items



Blow Guns

24" 77700-03392

48" 77700-03393

- Zinc-alloy body with satin finish
- Aluminum nozzle with durable oxidized finish
- 1/4" NPT air inlet
- 90 PSI working pressure / 150 PSI maximum working pressure
- Convenient angle design for hard-to-reach areas

77700-08593 (Metric)



Bolt Gauges

Metric 77700-08593

SAE 77700-08594

77700-08594 (SAE)

- Convenient gauges to accurately measure the diameter, length and thread pitch of your fasteners

Item No.	Max. Output	Air Inlet	Overall Length	Tube Length	Tube Diameter
77700-12156	120 PSI	1/4" NPT	10-5/8"	7"	3/8"

Stockman Knife

77700-12829

- Stainless steel blades and bolsters
- Includes Clip, Spey and Sheepfoot blades
- Rugged Delrin handle with jugged texture



Drive Chain Knife

77700-12830

- Stainless steel 3-1/4" blade with satin stone finish
- Easy assist open/close
- Sure-grip G10 textured handle
- Convenient pocket clip
- Safety lock
- 4" closed length



Tactical Knife

77700-12831

- 3" D2 steel blade with stone washed finish
- Ball bearing pivot system
- Sure-grip G10 textured handle with accent trim
- Convenient pocket clip
- Liner Lock
- 4" closed length



Multi-Purpose Pocket Knife

77700-12832

- Stainless steel 3-1/2" blade with serrated edge
- Ball bearing pivot system
- Sure-grip G10 textured handle
- Convenient pocket clip
- Liner lock
- 4" closed length



Deluxe Tactical Knife

77700-12833

- 3-1/4" satin finish D2 steel blade
- Ball bearing pivot system
- Sure-grip G10 textured handle with accent trim
- Stainless steel bolster
- Reversible pocket clip
- 4" closed length



8-in-1 Rancher's Multi-Tool Knife

77700-12834

- 2" stainless steel, black oxide coated blade
- Spring-loaded lockable pliers
- Wire cutter and adjustable wrench
- #1 flat head bit, #1 phillips bit, #2 flat head bit
- Convenient pocket clip
- 4-3/4" closed length



Retractable Utility Knife

77700-02485

- Quick change blade mechanism
- Smooth retracting/locking blade advance
- Includes three replacement blades



Folding Knife

77700-02482

- Closed: 3.9" Open: 6.3"
- Stainless steel blade



HAND TOOLS

12" Adjustable Wrench

77700-09004

- Versatile, large jaw capacity up to 1-11/32" (34mm)
- Durable chrome molybdenum alloy steel
- Steel jaws hold their grip
- Adjustable thumb wheel accommodates standard or metric sizes



Pliers

- Zinc plated construction resists corrosion
- Drop forged and heat treated for strength and durability

Item No.	Description
77700-04741	6-1/2" Slip Joint Pliers
77700-04742	8" Slip Joint Pliers
77700-04743	10" Adjustable Pliers
77700-04745	8" Leather Plier Holder



77700-04741 77700-04743 77700-04742 77700-04745



Telescoping Magnetic Pickup Tool

77700-02479

- Telescopes from 6-1/2" to 33"
- Powerful 5 lb. magnet features shielded sides for targeted pickups



25' Dual Rule Tape Measure

77700-02481

- Tough, impact resistant plastic case
- Easy-to-read tape markings in inches and centimeters
- Hands-free blade lock

14" x 6-1/4" Magnetic Tray

77700-03677

- Corrosion resistant stainless steel tray
- 3 powerful permanent magnets



Magnetic Parts Tray

77700-02476

- 4-1/4" corrosion resistant stainless steel dish
- Rubber covered magnetic base



Stainless Steel Scraper

77700-02478

- Rigid stainless steel go-thru blade with metal capped handle for strength and durability
- Comfortable TPR handle for maximum grip



1/2" Drive x 30 mm Standard Socket

77700-03678

- Meets and exceeds ANSI standards
- Fits most mower blade bolts
- Chrome vanadium



1/2" Drive x 30 mm Heavy Duty Impact Socket

77700-03679

- Meets and exceeds ANSI standards
- Fits most mower blade bolts
- Black chrome molybdenum



Heavy Duty Multi-Purpose 2" Hitch with Ball Mount

77700-10702

- Universal design—fits all 2" receivers
- 2" Ball mount
- Integrated tow hook
- Clevis pin connector
- Durable powder coated steel construction
- Ball with 3.5" of rise for optimal towing height
- Hitch pin included



Heavy Duty Adjustable 2" Hitch with Ball Mount

77700-10703

- Universal design—fits all 2" receivers
- 2" Ball mount
- Integrated tow hook
- Clevis pin connector
- Durable powder coated steel construction
- Ball with 3.5" of rise and over 3.5" of vertical adjustment
- Adjusts to keep trailer tongue at optimal height
- Make height adjustments quickly and easily with (2) included pins



Tow Recovery Kit

77700-12961

- Keep all your gear organized and tangle free
- Tow Recovery Kit will safely and quickly get your equipment where it needs to go
- Assembled by experts to cover your towing needs
- Heavy duty tow kit up to 5,000 lb tow capacity
- Protect your valuable equipment
- Great for rescuing stranded vehicles
- Heavy duty storage bag



TOWING KITS & DIAGNOSTIC TOOLS

Towing Kits

- Quickly test, clean and repair truck and trailer connectors
- Extends the life of the harnesses
- Promotes safety and limits road hazards
- Cleaning tools remove corrosion and re-size terminals to proper dimensions
- Includes cleaner/re-sizer, DeoxIT® Restore/Enhance and harness tester

Item No.	Pin Style	Application
77700-03673	6 Round	Light and medium duty truck, RV and trailer
77700-03674	7 Flat (Spade)	Medium duty truck, SUV and trailer
77700-03675	7 Round	Heavy duty tractor and trailer
77700-03881	4/5 Pin	Cars and trucks, agricultural, industrial, landscaping, contracting, sporting, and fleet connections



77700-03673



77700-03674



77700-03675



77700-03881



4/5 Pin Harness Checker

77700-02457

- Great for tracking truck and trailer lighting functions
- Each LED light corresponds to the circuit being energized
- Plugs in-line with truck and trailer
- Easy to connect ground terminal for trailer lighting setup



7 Flat Pin Circuit Tester

77700-02458

- Quickly tests and troubleshoots truck and trailer electrical circuits and connectors
- Plugs into truck side trailer harness
- LED lights indicate each circuit is complete and the current is getting to the plug



Heat Shrink Tube Kit

77700-09003

- 171 pieces
- 2:1 shrink ratio
- UL approved polyolefin heat shrink tubes
- Operating temp.: -67°F to 257°F
- Shrink temp: starts at 158°F - ends at 230°F
- Maximum electrical rating: 600 volts

Tire Recovery Kit

77700-12960

- Essential road repair kit will fix all your vehicle tire emergencies and get you back on the road again
- Heavy duty tool bag keeps all your essentials together and easy to find
- Breakdowns happen, be prepared with this Tire Recovery Kit and you will have less downtime in productivity



Cordless Tire Inflator

77700-12849

- Inflates up to 150 PSI
- Measures tire pressure
- Auto cut-off when set pressure is reached
- ABS body with digital gauge: shows pressure in PSI, BAR, kPa
- Top LED light
- USB-C fast charging
- Portable, battery operated, rechargeable and fits in glove box



Heavy Duty Tire Pressure Gauge

77700-08991

- Steel case with polished brass bezel and 2" dial
- Fully geared brass movement
- 0-60 PSI
- 10" extension hose for tough to reach valve stems



Pencil Tire Gauge

77700-02468

- For use with air service only
- Reads from 5 to 75 PSI
- Easy-to-read, four sided nylon scale is in 2 PSI increments



Dial Tire Gauges

- Steel case with polished brass bezel and 2" dial
- Full geared, precision movement with bronze bourdon tube
- Not affected by changes in temperature, humidity or altitude



Item No.	PSI Range
77700-03676	0-30
77700-02469	0-100

SAFETY PRODUCTS

ABC Fire Extinguishers

- Specially formulated ammonium phosphate-base dry chemical extinguishers may be effectively used to combat Class A and Class B fires as well as having a Class C listing
- Allows use in the presence of energized electrical equipment
- Designed and engineered to the highest-quality standards
- Meets DOT, Coast Guard and OSHA requirements
- Operating temperature: -65° F to 120° F
- Operating range: 2-1/2 lb. (9 to 15 ft.), 5 lb. (12 to 18 ft.), 10 and 20 lb. (15 to 21 ft.) - minimum distance of 8 ft. is most effective and prevents spreading of burning material
- Discharge time (minimums): 2-1/2 lb. size (10 seconds), 5 lb. size (14 seconds), 10 lb. size (20 seconds) and 20 lb. size (30 seconds)



Item No.	Description
77700-10084	2-1/2 lb. capacity - U/L Rating 1A-10B:C - Includes Vehicle Bracket
77700-10085	5 lb. capacity - U/L Rating 2A-10B:C - Includes Vehicle Bracket
77700-10086	10 lb. capacity - U/L Rating 4A-10B:C
77700-10090	20 lb. capacity - U/L Rating 20A-120B:C

Water Fire Extinguisher

77700-10088

- The cooling, soaking and penetrating 30-45 foot stream and 50-second discharge time make it a very effective and operator-friendly extinguisher for use on Class A fires
- 2-1/2 gallon capacity - U/L Rating 2A
- Stainless steel stored-pressure extinguisher
- Operating temperature: 40° F to 120° F
- Operating range: 45-55 ft.
- Operating time: 50 seconds



Mounting Brackets

Item No.	Holding Capacity
77700-10087	10 lb.
77700-10089	20 lb. & 2-1/2 gallons

Slow Moving Vehicle Signs

- 14"H x 16"W, made with high-intensity, micro-prismatic reflective and fluorescent materials
- ASAE (S276.6) approved and State of Illinois compliant
- Complete, easy to install hardware kit available for mounting (77700-03391—purchase separately)



Item No.	Material	Thickness
77700-03388	Aluminum	.04"
77700-03389	Plastic	.80"
77700-03390	Adhesive	-
77700-03391	Mounting Kit	-

Safety Kit

77700-12959

- Safety Kit provides easy access that can be carried to the job site
- Conveniently packaged with everything needed to keep you and your crew safe from noise, falling or flying objects, inattentive drivers, and accidents
- Ideal for home and on the road to protect your hearing, eyes, head, hands and body from accidents
- Heavy duty storage bag



100 Piece First Aid Station Service Bays Cabinet

77700-13491

- Best used in manufacturing and heavy industrial sites
- Sturdy and heavy-duty in a durable, type I & II metal case
- Exceeds ANSI 2021 Class B standards to keep you OSHA compliant with essential first aid supplies
- First aid supplies are boxed for painless re-ordering and quick and easy identification during an emergency



First Aid Kit

77700-02459

- 57-piece kit
- Rust-proof, durable polypropylene case
- Fits in vehicle glove box or can easily be wall-mounted
- Inner gasket seals out moisture so contents stay dry and ready to use



Wheel Spinners

77700-01540 Deluxe Wheel Spinner

- Split base design for easy mounting

77700-10674 Wheel Spinner

- Heavy duty spinner with ergonomic grip
- 12 piece display box
- Vinyl coating for lasting durability
- For effortless turning of tractors and other off-road equipment
- Clamp securely grips all wheels up to 1-1/4" thick
- Comfortable ergonomic handle with smooth spinning design



77700-01540

77700-10674

High-Intensity Warning Strobe

77700-05375

- High-intensity flash is visible for over one mile in clear conditions
- Flashes 70 times per minute with 300 candelas of brightness
- Dimensions: 5-1/4" tall, 4" diameter base
- Lanyard allows it to be carried like a lantern
- Two standard D batteries (not included) deliver 48 hours of continuous flashing



Hard Hats

- Unique, smooth crown protects from the danger of falling objects
- Convenient rear-located mechanism used to adjust the head size for comfort
- 360° removable, perforated and padded sweatband that keeps you cool
- SEI certified to meet ANSI Z89.1-2003 Type 1, Class E, G or C



77700-05374

77700-05367

Item No.	Description
77700-05367	Orange with CE imprint
77700-05374	Orange with Oval K logo

SAFETY PRODUCTS

Type R Class 2 Mesh Safety Vest with Two-Tone Trim

- Reflective stripes on contrasting trim make workers much more noticeable in low light and broad daylight
- 2" Silver tape reflective material
- Pockets: One upper left front and one lower right inside
- Material: 100% polyester mesh
- Color: Hi-Vis Orange
- Meets ANSI/ISEA 107 standards



Item No.	Size
77700-12148	Small/Medium
77700-12149	Large/X-Large
77700-12150	2X-Large/3X-Large

Safety Vest Class 2

- Hi-Vis Lime color, constructed from non-woven material
- Breathable, mesh vest features 2" 3M reflective tape, an inside pocket, 3 front snap closures and adjustable Velcro sides that accommodate changes in outerwear and for more flexible sizing
- Custom imprint available



Item No.	Size
77700-05376	Small/Medium
77700-05377	Large/X-Large
77700-05378	2X-Large/3X-Large

Kubota Safety Eyewear

- Fog and scratch resistant lenses
- TPR material increases its grip as it becomes moist to keep them on your face
- Tapered lenses eliminate refraction and block 99.9% of UVA/UVB/UVC rays
- Frames consist of a flexible and durable TR90/ Nylon compound material and wrap around with no side shield distortion
- Exceeds ANSI Z87.1+2012 safety standards
- 10-Unit Eyewear Display (77700-04481)
- Sold in package quantity of 3



77700-04462



77700-04466



77700-04470



77700-04465

Item No.	Lens	Frame	% Light Thru
77700-04461	Clear	Black	85%
77700-04462	Smoke	Black	16%
77700-04463	Clear	Gloss Black Nylon	65%
77700-04464	Aqua Precision Red Mirror	Gloss Black Nylon	13%
77700-04465	Smoke	Gloss Black Nylon	16%
77700-04466	Smoke	Gloss Black Nylon	16%
77700-04467	Polarized Aqua Precision Blue Mirror	Rubberized Matte Black Nylon	10%
77700-04468	Clear	*Polycarbonate Matte Black (Fits over existing eye wear)	85%
77700-04469	Smoke	*Polycarbonate Matte Black (Fits over existing eye wear)	16%
77700-04470	Copper	Camouflage Nylon	8%

* Unbranded



10-Unit Eyewear Display
77700-04481
Eyewear sold separately

Premium Cowhide Leather Mechanics Gloves
NEW

- Water repellent leather resists soaking
- Cowhide leather is soft & durable
- Spandex back stretches for a great fit
- Neoprene knuckle for added protection
- Adjustable wrist closure



Item No.	Size
77700-13389	Large
77700-13390	X-Large

Waterproof Winter Lined Suede Cowhide Gloves
NEW
77700-13487 One size fits all

- Genuine suede leather is soft & durable
- Waterproof to protect hands from getting wet
- 3M Thinsulate lining keeps hands warm
- Safety cuff protect wrists
- Great for truckers, agriculture, tow drivers
- One Size Fits All

Camouflage Gloves

- Realtree Xtra® camouflage
- Silicone palms provide strong, sure grip
- Adjustable wrist closure
- Provides the ideal grip for shooting, hunting, material handling, boxes and tools
- Machine wash, air dry



Item No.	Size
77700-12151	Medium
77700-12152	Large
77700-12153	X-Large
77700-12164	XX-Large

Mechanic's Gloves

- Durable synthetic leather palm
- Breathable form-fitting spandex back
- Slip-on style cuff for easy on, easy off
- Comfortable shirred elastic on front and back
- Machine wash, air dry



Item No.	Size
77700-03154	Medium
77700-03155	Large
77700-03156	X-Large
77700-03646	Women's Medium (Pink)

77700-03646

Suede Winter Lined Work Gloves

- Genuine suede cowhide leather
- 3M Thinsulate lining keeps hands warm
- Shirred elastic back for a great fit
- Soft & durable leather
- Premium keystone thumb design



Item No.	Size
77700-02464	Large
77700-02465	X-Large

Leather/Canvas Gloves
77700-02466

- Suede cowhide leather fingertips, palm and knuckle strap
- Elastic back and rubberized safety cuff
- One size fits all



GLOVES

Heavy Duty Mechanic's Gloves

- Reinforced palm patches for extra protection
- Silicone anti-slip fingertips for extra grip
- TPR back of finger protection against impact & pinches
- Adjustable wrist tab keeps out dirt



Item No.	Size
77700-07910	Medium
77700-07911	Large
77700-07912	X-Large

Touchscreen Mechanic's Gloves

- Touchscreen fingertips
- Durable palm is protective and long lasting
- Padded palm reduces fatigue
- Adjustable wrist tab keeps out dirt



Item No.	Size
77700-07907	Medium
77700-07908	Large
77700-07909	X-Large

Winter Lined & Waterproof Touchscreen Gloves



- Waterproof & breathable lining keeps out moisture
- Touchscreen fingertips
- 3M Thinsulate lining keeps hands warm
- Durable palm is protective and long lasting

Item No.	Size
77700-07913	Large
77700-07914	X-Large

Premium Water Repellent Leather Work Gloves



- Water repellent leather resists soaking
- Leather is soft & durable
- Keystone thumb for added movement & comfort
- Elastic wrist for a great fit
- Our nicest & softest leather work gloves

Item No.	Size
77700-02461	Women's Medium
77700-02462	Men's Large
77700-02463	Men's X-Large

Powder-Free 6 mil Nitrile Gloves

- Breakthrough pH 5.5 technology made to match healthy skins natural pH 5.5 levels to ensure the most comfortable fit yet
 - Unique formulation reduces excess perspiration
 - Quadruple washed—no excess chemicals lingering on glove
- Super strength and stretch—no more tearing
- Fully textured grip



Item No.	Description
77700-04747	Orange Lightning - Medium
77700-04771	Orange Lightning - Large
77700-04772	Orange Lightning - X-Large
77700-04773	Orange Lightning - XX-Large
77700-04746	Black Lightning - Medium
77700-04497	Black Lightning - Large
77700-04498	Black Lightning - X-Large
77700-04499	Black Lightning - XX-Large

**GB250 - Boost® Max™ 5250 Amp
UltraSafe Lithium-Ion Jump Starter**

77700-12142

- Over 5250-amperes of starting power, it can jump start gasoline and diesel engines up to 16-liters
- Safe and easy to use battery jump starter pack without the worry of incorrect connections or sparks
- Safely connect to any 12-volt battery with our mistake-proof design featuring spark-proof technology and reverse polarity protection
- Jump starts almost every type of vehicle and equipment, including semi-trucks (up to class 8), motorhomes, coaches, buses, mining, agricultural, construction, and vocational equipment—6, 8, 12, and 16 cylinder - and more!
- Integrated digital battery voltmeter for enhanced diagnostics
- Jump starters this powerful typically are enormous and weigh hundreds of pounds, but our high discharge lithium technology makes it the most compact and lightweight design in the world - weighing a mere 15-pounds
- It's not just a lithium jump starter but also a portable power bank for recharging smartphones, tablets, and other USB devices, with an ultra-bright 600-lumen LED flashlight with seven light modes, including emergency strobe and SOS
- Includes: Lithium Battery Jump Starter, 56-Watt XGC Power Adapter, 12-Volt 2-Foot XGC Cable, Protective Carrying Case and User Guide & Warranty Information
- One year warranty



BATTERY JUMPSTART

GB150 - Boost® Pro™ 3000 Amp UltraSafe Lithium Jump Starter

77700-12140

- Compact, yet powerful lithium jump starter rated at 3,000 amps up to 80 jump starts on a single charge
- An ultra-safe and mistake-proof design with spark-proof technology and reverse polarity protection, which allows it to safely connect to any battery
- Ideal for a wide range of small vehicle applications to larger vehicles with 9.0L gas and 7.0L diesel engines
- Equipped with a built-in voltmeter that reads the voltage of the vehicle's battery for enhanced diagnostics and troubleshooting
- An ultra-bright 500 lumen LED flashlight with 7 light modes including SOS and emergency strobe
- Power 12V devices anywhere, like tire inflators, power inverters, and more
- Recharge your personal devices on the go, like smartphones, tablets, e-watches and more—up to 6 smartphone recharges
- Includes: Lithium Battery Jump Starter, XGC 12V Male Adapter, XGC 12V Female Adapter, XGC Extension Cable, Micro USB Cable, Microfiber Storage Bag and User Guide & Warranty Information
- One year warranty

GB70 - Boost® HD™ 2000 Amp UltraSafe Lithium Jump Starter

77700-12138

- Compact, yet powerful lithium jump starter rated at 2,000 amps up to 40 jump starts on a single charge
- An ultra-safe and mistake-proof design with spark-proof technology and reverse polarity protection, which allows it to safely connect to any 12V battery
- An ultra-bright 400 lumen LED flashlight with 7 light modes including SOS and emergency strobe
- Recharge your personal devices on the go, like smartphones, tablets, e-watches and more - up to 6 smartphone recharges
- Power 12V devices anywhere, like tire inflators, power inverters, and more
- Designed for gas engines up to 8 liters and diesel engines up to 6 liters for cars, SUVs, trucks, boats, RVs, and more
- Includes: Lithium Battery Jump Starter, XGC 12V Male Adapter, XGC 12V Female Adapter, XGC Extension Cable, Micro USB Cable, Microfiber Storage Bag and User Guide & Warranty Information
- One year warranty



Boost® Pro™ Protective Case

77700-12141



- Made of thermoformed EVA, the lightweight and durable molded exterior has a water resistant, rubber-like finish
- Heavy-duty reverse coil zipper with built-in reinforced handle and custom over-molded pull tab
- Boost insert molded tray interior with soft black melange velvet lining for secure fit
- Reinforced pockets for securely holding clamps, extensions or other accessories
- Case Fits GB150 (77700-12140)



Protective Case for Boost® HD™

77700-12139



- Lightweight, durable, and rugged custom exterior
- Equipped with a zipper closure and reinforced handle for storing and carrying Boost®
- Offers protection from moisture, impact, dust, and environmental factors
- Additional pockets
- Weather resistant (*Do not submerge in water*)
- Case Fits GB70 (77700-12138)

GB40 - Boost® 1000 Amp UltraSafe Lithium Jump Starter 77700-12135

- Compact, yet powerful lithium jump starter rated at 1,000 Amps - up to 20 jump starts on a single charge
- An ultra-safe and mistake-proof design with spark-proof technology and reverse polarity protection, which allow it to safely connect to any battery
- An ultra-bright 100 lumen LED flashlight with 7 light modes, including SOS and emergency strobe
- Recharge your personal devices on the go, like smartphones, tablets, e-watches and more - up to 4 smartphone recharges
- Designed for gas engines up to 6 Liters and diesel engines up to 3 Liters for cars, boats, lawn mowers and more
- Includes: Lithium Battery Jump Starter, Heavy-Duty Precision Battery Clamps, 12V Car Charger, Micro USB Cable, Microfiber Storage Bag and User Guide & Warranty Information
- One year warranty



Protective Case for Boost® 1000 Amp Ultrasafe Lithium Jump Starter 77700-12136

- Lightweight, durable, and rugged custom exterior
- Equipped with a zipper closure and reinforced handle for storing and carrying Boost®
- Offers protection from moisture, impact, dust, and environmental factors
- Additional pockets
- Weather resistant (*Do not submerge in water*)
- Case Fits GB40 (77700-12135)

GBC007 - Boost® Eyelet Cable with X-Connect Adapter 77700-12137

- Heavy-duty battery eyelet design for automotive, powersport, marine, RV, and truck applications
- Hard-mount the eyelets for quick and convenient charging or jump starting
- Lie-flat design for seamless installations with M6 (1/4-inch) hole size
- Made from durable, heat stabilized 8AWG silicone wire that maintains its flexibility in cold weather environments
- Designed to efficiently transfer maximum current flow with minimal power loss
- Compatible with Boost® 1000 Amp UltraSafe Lithium Jump Starter
- Attach the adapter for compatibility with GENIUS2 (77700-12160) and GENIUS10 (77700-12154)



BATTERY CHARGING

GENIUSPRO25 25-Amp Battery Charger, Battery Maintainer & Battery Desulfator 77700-12155

- 6-volt (50-amps), 12-volt (50-amps), and 24-volt (25-amps) for lead-acid automotive, marine, and deep-cycle batteries, including flooded, gel, AGM, and maintenance-free, plus lithium-ion
- Force Mode for extremely dead batteries lower than 1-volt, manually turn on force mode to detect and charge batteries all the way down to zero volts
- Safely charge any battery year-round
- Charge continuously without user intervention and with zero risk of overcharging your battery
- Featuring ultra-flexible silicone cabling, down to -40°C, with protective nylon braided shielding for maximum protection against abrasion
- The new integrated thermal sensor automatically monitors and adjusts the charging cycle based on fluctuations of ambient temperature
- Avoids under-charging in cold weather down to -4°F and avoids over-charging in hot weather up to 122°F
- Charging modes: Lead-Acid, AGM, Lithium, Repair, Supply, Force, 5A Mode
- Advanced diagnostics: Standby, Bad Battery, High Voltage, Reverse Polarity, Temperature
- Includes: GENIUSPRO25 Battery Charger w/ Interchangeable Connectors, (1) Genius PRO Clamps w/ Integrated Eyelets, (1) 10' Extension Cord, (1) EVA Case, (2) Self-Tapping Screws, Type A, C, G, and I Power Cables and User Guide & Warranty Information
- Three year warranty



ADVANCED DIAGNOSTICS.



STANDBY.



The charger is in standby mode or the battery voltage is too low for the charger to detect.

HIGH VOLTAGE.



The battery voltage is too high for the selected charge mode. Check the battery and charge mode.

BAD BATTERY.



There is a possible battery short or the battery will not hold a charge. Have the battery checked by a professional.

POLARITY.



Charger is connected to the battery in reverse. Reverse the connections.

HIGH TEMP.



Charger internal temperature too high / Charger will resume function once the Charger internal temperature drops.

LOW TEMP.



All Error LED's will flash. Ambient temperature is too cold. Charger will resume once the temperature is back within operating limits.

GENIUS10 10-Amp Battery Charger, Battery Maintainer & Battery Desulfator

77700-12154

- Plug-in, connect to the battery, select a charge mode, and start charging your battery
- Fully-automatic, worry-free battery charger for year-round use
- Designed for 6-volt and 12-volt lead-acid automotive, marine, and deep-cycle batteries, including flooded, gel, AGM, maintenance-free, and lithium-ion batteries
- Charge dead batteries as low as 1-volt or use the all-new Force Mode that allows you to take control and manually begin charging dead batteries down to zero volts
- Integrated thermal sensor detects the ambient temperature and alters the charge to eliminate over-charging in hot climates and under-charging in cold climates
- Built-in desulfation mode for the most corroded batteries
- Auto detection with smart diagnostic indicators starts a Repair Mode integrated within a 9-step charging profile
- Leave plugged in 24/7 with no worries of overcharging
- Automatically returns to its last selected mode
- Includes: GENIUS10 Battery Charger w/ Interchangeable Connector, Clamps w/ Integrated Eyelets (M10), Mounting Bracket w/ Strap, (2) Self-Tapping Screws and User Guide & Warranty Information
- Three year warranty



GENIUS10

10A **230Ah** **150W**
CHARGING CURRENT. BATTERY CAPACITY. OUTPUT POWER.

CHARGE MODES.

6V **12V** **12V** **12V**
AGM LITHIUM

12V **12V** **6V**
REPAIR SUPPLY AGM

TECH SPECS.

3.33 LBS
7.1"x 3.6"x 2.3"



BATTERY CHARGING & JUMPER CABLES



GENIUS2

2A CHARGING CURRENT. **40Ah** BATTERY CAPACITY. **30W** OUTPUT POWER.

CHARGE MODES.

6V **12V** **12V** **12V**
AGM LITHIUM

TECH SPECS.

1.10 LBS
3.7" x 2.4" x 1.7"

GENIUS2 2-Amp Battery Charger, Battery Maintainer & Battery Desulfator

77700-12160

- Designed for 6-volt and 12-volt lead-acid automotive, marine, and deep-cycle batteries, including flooded, gel, AGM, and maintenance-free, plus lithium-ion batteries
- An integrated thermal sensor detects the ambient temperature and alters the charge to eliminate over-charging in hot climates and under-charging in cold climates
- Charges dead batteries as low as 1-volt or use the all-new Force Mode that allows you to take control and manually begin charging dead batteries down to zero volts
- Plug-in, connect to the battery, select a charge mode, and start charging your battery
- A fully-automatic, worry-free battery charger for year-round use
- Detects sulfation and acid stratification and restores lost performance for stronger engine starts and extended battery life
- Charge and maintain cars, motorcycles, lawn mowers, ATVs, tractors, trucks, SUVs, boats, classic cars, hot rods, and more!
- Includes: GENIUS2 Battery Charger w/ Interchangeable Connector, Clamps w/ Integrated Eyelets (M6), Mounting Bracket w/ Strap, (2) Self-Tapping Screws, User Guide & Warranty Information
- Three year warranty



GC009 - X-Connect SAE Adapter

77700-12161

- Convert X-Connect to SAE power adapters
- Conveniently connect to any existing wiring connections
- Perfect for connecting to other 12-volt devices
- More ways to charge with plug-n-play accessory changes
- Built-in fuse protection for increased safety
- Rugged, watertight connector for extreme environments
- Connect GENIUS to existing SAE—Compatible with GENIUS2 (77700-12160) and GENIUS10 (77700-12154)



Construction Grade Jumper Cables

77700-09781

- 25 ft x 1 GA
- Heavy duty, tangle-free booster cables
- Extra flexible for easy use
- Resists oil, gas & acid
- Fits top & side mount batteries
- 900 AMP CCA

Battery Corrosion Preventative

77700-13383

12.25 oz.

NEW

STOPS CORROSION

- Formulated to make all surfaces impenetrable to corrosion-causing acid fumes
- Environmentally safe and resistant to reversion, moisture, shock and vibration

EXTEND BATTERY LIFE

- Stops battery corrosion for the life of your battery.
- Eliminates resistance for improved cranking power

UNIVERSAL APPLICATION

- Apply to any vehicle battery.
- Suitable for battery terminals, cables, hold-downs, enclosures, boxes and carriers



Battery Cleaner & Acid Detector

77700-13384

14 oz.

NEW

REMOVES CORROSION

- Instantly neutralizes, dissolves and removes battery corrosion
- Formulated to assure maximum current flow and reduce potential voltage leakage

EXTEND BATTERY LIFE

- Stops battery corrosion for the life of your battery when used in conjunction with NCP2 Battery Corrosion Preventative (77700-13383)

- Eliminates resistance for improved cranking power

FAST-ACTING

- Features a specialized foaming agent which turns pink upon contact with battery acid



NEW



Battery Treatment Kit

77700-13385

ALL-IN-ONE COMPLETE PROTECTION BATTERY TREATMENT KIT

Kit includes:

- Battery Corrosion Preventative
- Battery Cleaner
- Battery Terminal Brush
- Convenient kit for DIY or for service shop tickets for battery maintenance



TURF & LANDSCAPE ACCESSORIES

TOOL-N-GO Tractor Storage System

77700-13407 3 Piece Kit = (1) 13" and (2) 20"

77700-13408 2 Piece Kit = (1) 12" and (1) 13"

77700-13409 1 Piece Kit = (1) 13"

- Store pins, bolts, wrenches, hand tools, chains, fencing supplies, chainsaw tools, ratchet straps and more
- Heavy duty polycarbonate construction
- Strong holding magnetic closure
- Rust and corrosion resistant for lasting durability



Scan the QR code to view a demo video!

NEW

KUBOTA STANDARD L SERIES	77700-13409 1 PC. KIT	77700-13408 2 PC. KIT	77700-13407 3 PC. KIT
Loader LA 525		✓	
Loader LA 526		✓	
Loader LA 765		✓	
Loader LA 766		✓	
KUBOTA GRAND L60 SERIES			
Loader LA 555	✓		
Loader LA 805	✓		
Loader LA 1055			✓
KUBOTA MX SERIES			
Loader LA 1065			✓



Smart storage solution for your front end loader



Power Equipment Covers

77700-12844

Ideal for String Trimmers, Edgers, Pole Saws, Brush/Hedge Trimmers

- Protect your power equipment engine from the outdoor elements
- 100% Waterproof & dustproof
- Ideal for open trailer transportation or storage
- Resists mold and UV rays
- No stretch, 100% polyester
- Covers up to 10-1/2" diameter x 11-1/2" length

Universal Light Kit

77700-09075

- Five high-intensity LED's in each light
- 1,000 lumens per light
- Single harness
- Housing is IP67 rating
- Fits all Tractors, Zero-Turn Mowers, F-Series Mowers, and TLB Models
- Includes: 2 Lights, 2 Angle Brackets, 4 Large U Clamps, 2 Nuts/Bolts, 1 Switch & 1 Harness



SZ Series Cup Holder Kit

77700-12080

- Heavy duty metal construction for lasting durability
- Powder coat finish resists corrosion
- Molded cup holders keep bottles, cups and cans secure

Battery Maintenance
Turf & Landscape Accessories

41" 8 Drawer Top Chest Tool Cabinet

77700-13371

41" Tool Box 11 Drawer Cabinet

77700-13372

41" Tool Box 11 Drawer Chest & Cabinet

77700-13373

- Heavy duty 14 gauge steel frame and 18 gauge steel sides with four 6" x 2" mag wheel casters (two lockable swivels and two rigid)
- Drawers feature ball bearing glides with a load capacity of 100 lbs. per drawer and 200 lbs. per drawer with double glides

Item No.	Width	Depth	Height
77700-13371	41"	25"	21-3/8"
77700-13372	41-1/2"	25"	40-1/2"



CUSTOMIZE YOUR TOOLBOX!

41" Tool Chest/Cabinet Combo with Magnetic Decal Set

- Comes complete with Top Chest, Roller Cabinet and Magnetic Decal Set!

Item No.	Decal Design
77700-13374	RTV
77700-13375	Tractor
77700-13376	SVL / Construction



41" Cabinet Magnetic Decal Kits

- Heavy duty and strong holding flexible magnetic strips
- Superb image quality with UV protection
- Performs well in all weather, and in temperatures from -15° F to 160° F



77700-13368



77700-13369



77700-13370

Item No.	Decal Design
77700-13368	Tractor
77700-13369	RTV
77700-13370	SVL / Construction

CARGO & TOOL STORAGE

Deluxe RTV Cargo Box

77700-08760

- Requires two pairs of KAS Clamps (K7811-99560) and one Mounting Bracket (77700-V0838) (must be ordered separately)
- Kubota engineering designed and approved Deluxe RTV Bed Box features 4.5 cu. ft. of cargo capacity
- Tough and durable polyethylene construction resists corrosion, water and dust
- Lockable latches to secure your cargo
- Easy-to-lift covers with lock in detents providing easy access from either side of the box
- Sliding and removable tool trays for better organization
- Fits RTV-X900, RTV-X1100, RTV-X1120, RTV-X1140 and RTV-XG850

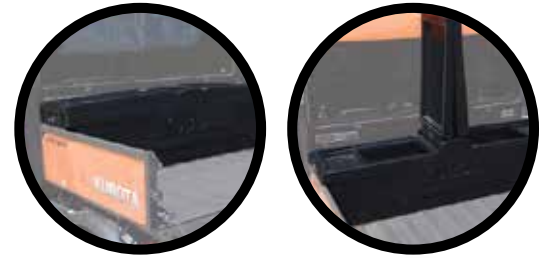

K7811-99560, must be ordered separately



36" Professional 5 Drawer Extra Capacity Service Box

77700-06140

- Outer dimensions: 36"W x 25.5"D x 29"H
- 16/18 gauge steel construction with specially engineered frame and handles that make it easy to slide and move service box
- 5 big reinforced drawers with quiet ride foam liners: 2 deep (30.84"W x 20"D x 4.5"H) and 3 standard size drawers (30.84"W x 20"D x 2.125"H)
- Casters (5" x 2" set of 4) sold separately (77700-02848)

Heavy Duty Parts Bins

- Organize parts, inventories, shorten repair times and minimize parts handling
- Heavy-duty bins securely stack atop each other, sit on shelving and hang from racks, panels, rails and carts
- Sturdy, one-piece construction is water, rust and corrosion-proof
- Molded of high-impact polypropylene, these bins are unaffected by weak acids and alkalis
- Guaranteed not to crack or break under normal load conditions as stated in the 1-year limited warranty



Pins not included

Item No.	Description	L x W x H	Pieces	Color
77700-10785	Storage Bin	14.75" x 5.5" x 5"	12	Black
77700-10787	Storage Bin	14.75" x 8.25" x 7"	12	Black
77700-10788	Storage Bin	14.75" x 16.5" x 7"	6	Black
77700-10789	Bin Divider	5.5" x 5"	6	Black
77700-10790	Bin Divider	8.25" & 16.5" x 7"	6	Black

Multi-Pocket Tool Bags

- Large opening for easy access
- Double-layered construction for maximum performance, resists moisture and abrasion
- Easy-pull heavy duty zipper and reinforced stitching on handle for durability
- Rigid waterproof base



77700-12840



77700-12956

Item No.	Size	L x W x H	Pockets	Weight Bearing Cap.
77700-12840	Small	12" x 9" x 5.5"	12: 6 interior + 6 exterior	22 lbs.
77700-12956	Medium	16.5" x 10.2" x 11.8"	15: 8 interior. + 7 exterior	66 lbs.
77700-12955	Large	17.9" x 11" x 11.8"	15: 8 interior. + 7 exterior	85 lbs.



Tool Bucket Organizer

77700-12841

- 30 Assorted pockets: 8 interior & 22 exterior
- 3 Interior loops for hammers, prybars and more
- Fits most 5-gallon buckets, sold separately (77700-12850 below)
- Deep pockets to accommodate a wide range of tools
- Water-resistant, rugged, heavy gauge 600 denier polyester
- Tools not included



5 Gallon Utility Bucket

77700-12850

- Premium 5 gallon round bucket offers a rugged and durable way to store products
- Wire bail handle with plastic grip
- HDPE

BIGTOOLRACK®

Ultimate Rack

77700-08997

- The BIGTOOLRACK® tractor attachment adds valuable cargo space
- Ideal mobile storage system...no more running back to the tool shed
- Haul your tools and supplies safely and securely to your worksite
- Easy and convenient 3 point hitch attachment, and trailer tow feature plus quick-hitch compatible
- Heavy duty wheels for easy rolling and storing
- Heavy duty steel construction with durable powder coat finish
- Maximum cargo capacity of 600 lbs.
- Active tailgate
- Will give your tractor ballast
- Rack Dimensions: L: 54" x W: 35.5" x H: 45.75"
- This beast hauls it all!

- ✓ Landscaping
- ✓ Fencing
- ✓ Farm/Ranch
- ✓ Firewood
- ✓ Trash/Cleanup

“There's no doubt that this is one of the most valuable pieces of tractor equipment I have. I recommend it every chance I get...”
Todd in VA



Scan the QR code to view a demo video!



Universal Tool Holder

77700-10740

- Secure your large handle hand tools with this rubber strap tool holder
- Includes one bracket, one rubber strap and all mounting hardware



Grass Trimmer Kit Classic

77700-10739

- Secure your grass trimmer, pole saw or any other long handle tool with this system
- Includes two holders, four rubber straps and all mounting hardware

5N1 Tool Holder

77700-10738

- Perfect addition for the Ultimate Rack
- Comes standard with all mounting hardware, chainsaw tooth guard and 8 rubber grommets to protect your long handle tools
- Very durable textured black powder-coat finish



Four Hole Tool Holder

77700-10741

- Easily slide four long-handled tools in this holder
- The BIGTOOLRACK has predetermined holes in the rack to allow you to add multiple holders
- Includes holder and all mounting hardware



Tool Storage

RopsRackPack®

- Attaches quickly and easily to your tractor or zero-turn mower — no drilling, no hardware
- Safely and securely transport landscape tools, power equipment, supplies and more to your worksite
- Made from heavy duty, ballistic nylon with an industrial strength hook/loop closure
- Attaches to your existing rollbar
- Includes: 1 - Anchor Sleeve, 2 - Side Sleeves, 2 - Straps, 2 - 24" Twist Ties

Item No.	Description
77700-10695	Fits all Kubota Tractors, ZD Series Mowers, Z100 Series Mowers
77700-10696	Fits all Kubota Z400 Series and Z700 Series Zero Turn Mowers



Work Gear Bag

77700-10694

- Made from heavy duty, ballistic nylon
- Easily and quickly attaches to your Kubota RTV or Kubota stand-on mower
- Includes strap kit to attach to your RopsRackPack® and buckles for attaching to your Ultimate Rack
- Gear Bag is 18" long x 4" wide x 11" tall



18 oz. Quick Fill Portable Fuel Bottle

77700-10697

- Convenient 18 oz. bottle for quick refill of gas powered lawn tools & equipment
- Spill-proof—no caps to unscrew
- Self-venting / auto shut-off



10" S-Biner® Dual Carabiner

77700-10783

- Allows you to hang your trimmer, leaf blower and other large items



SPRAYERS

Portable Sprayers

- Handle action piston pump
- Large mouth for easy filling
- Single conical spray tip
- Pressure relief valve
- 8L (77700-03398) features a 23" trigger lance with an ergonomic handle and easy-to-use spot spray wand



Item No.	Capacity	Max. PSI
77700-03397	0.53 Gallons	10
77700-03398	2.1 Gallons	43

Backpack Sprayer

77700-03399

- 4.25 gallons (16 liters)
- Develops 15-90 PSI
- Quick fitting harness and padded straps
- 4 spray tips
- Wide-mouth lid
- Lever action piston pump
- Available spare parts kit
- Quality seals and built-in screens
- Lance clip and carry handle
- Ideal for insecticides, fertilizers, herbicides and disinfectants



5 Gallon Rechargeable Spot Sprayer

77700-12143

- Rechargeable Lithium ION 12V battery
- Sprays 30 gallons on one charge
- 1.0 GPM demand pump
- Lever handgun
- Telescoping handle
- 5' Hose with spray gun
- AC charger with built-in storage compartment
- Large 8" wheels
- Molded fill level lines in gallons and liters



15 Gallon Spot Sprayer

77700-03500

- 15 gallons (57 liters)
- 12 volt pump spot sprayer
- Polyethylene tank with mold-in drain with cap
- Trigger gun with adjustable nozzle
- 15 feet of 3/8" hose
- 5" screw-on lid with tether
- Adjusts from fine mist to solid stream
- Ideal for insecticides, fertilizers, herbicides and disinfectants
- Applications include ranch/farm, weed and insect control, livestock and trees/shrubs



25 Gallon Sprayer

77700-08963

- 3 nozzle boomless spray pattern allows for 140" (11.6') of coverage
- Chemically-resistant polyethylene tank
- 2.2 GPM pump
- 60 PSI gauge
- Deluxe 18" sprayer wand
- Adjustable relief with gauge
- Multi-purpose sprayer fits most RTV's, ATV's & UTV's



25 Gallon Boomless Tow Behind Sprayer

77700-12144



- Boomless system allows 100" of spray coverage
- Boomless nozzles can be independently shut on & off for directional spray of fence rows & ditches
- 60 PSI gauge
- 2.2 GPM demand pump
- Polyethylene tank with mould-in drain with cap
- 25' Hose with spray gun
- Deluxe pistol grip handgun sprays up to 25' vertical and 35' horizontal
- Molded wand clips
- Large 5" fill lid with tether
- 8' Wiring harness with battery clips

40 Gallon Trailer Sprayer

77700-08962

- Heavy duty frame
- 5 nozzle boom coverage up to 100"
- Chemically-resistant polyethylene tank
- 2.2 GPM pump
- 60 PSI gauge
- Deluxe 18" sprayer wand
- Heavy duty wand clips
- Adjustable pressure relief with gauge
- 3 piece folding adjustable boom
- Wide tires



SPRAYERS



40 Gallon RTV Sprayer with Hitch Mount Boom

77700-08964

- Unique 2" receiver mount boom provides 300° of adjustability
- 7 nozzle breakaway boom coverage up to 140"
- Nozzles include check valve
- Chemically-resistant polyethylene tank
- 2.2 GPM pump
- 60 PSI gauge
- Deluxe 18" sprayer wand
- Adjustable relief with gauge

Sprayer Boom

77700-09601

- Sprayer boom for Kubota 40 gallon sprayer
- Compatible with many other sprayers!



60 Gallon 7 Nozzle 3-Point Hitch Sprayer

77700-12146

- 60 PSI gauge
- 5.0 GPM demand pump
- 140" 7 nozzle spray boom coverage
- Polyethylene tank with mold-in drain with cap
- 25' hose with spray gun
- Deluxe pistol grip handgun sprays up to 25' vertical and 35' horizontal
- Molded wand clips
- Large 5" fill lid with tether
- 8' wiring harness with battery clips

60 Gallon RTV Spot Sprayer

77700-12145

- 60 PSI gauge
- 5.0 GPM demand pump
- RTV clamps
- Polyethylene tank with mould-in drain with cap
- 25' hose with spray gun
- Deluxe pistol grip handgun sprays up to 25' vertical and 35' horizontal
- Large 5" fill lid with tether
- 8' wiring harness with battery clips
- **Add a Boom - The 77700-09601 and the 77700-12147 can be used with this spot sprayer!**



24' Boomless Hitch Mount with 2 Nozzles

77700-12147



- 24' Wide spray pattern
- Works with the 77700-12145 60 Gallon RTV Spot Sprayer (above), 77700-08965 60 Gallon 3-Point Sprayer (below), and the 77700-12146 60 Gallon 3PT Sprayer (bottom left page 70)
- Hitch mount for 2" receiver
- Features 300° adjustability
- Requires 5.0 GPM pump
 - Front or rear mount
- Shut-Off valves to spray right or left side independently
- Corrosion resistant frame

60 Gallon 3-Point Sprayer

77700-08965

- 6 roller pumps with torque arm and quick coupler
- 7 nozzle breakaway boom coverage up to 140"
- Nozzles include check valve and quick caps
- Heavy duty frame with skid plates
- Chemically-resistant polyethylene tank
- 100 PSI gauge
- Deluxe 18" sprayer wand
- Adjustable relief with gauge
- Forward mounted on/off valve with protected gauge and plumbing



PORTABLE GRAIN & HAY MOISTURE TESTERS

Why Test Hay & Grain Moisture?

According to agricultural nutrition experts, the single most important factor influencing the quality of grain, hay and silage is moisture. Moisture management is a continuous process that requires the appropriate measuring tools. Protect your investment by testing moisture content before, during and after the season accurately and quickly using **Kubota Moisture Testers**.

HST-1 Advanced Hay, Straw and Silage Moisture Tester

77700-10675

- Automatically compensates for the bale density giving more accurate testing results
- Scales for hay/haylage, straw, hay silage, corn silage and alfalfa
- Heavy duty 20" (50.0 cm) stainless steel probe
- Automatic density compensation for more accurate results
- "Industry First" hay tester with temperature compensation
- USB port for scale and software updates, including exporting tests to your computer
- Hay and Haylage: 8% - 80% • Straw: 8% - 25% • Hay Silage: 30% - 84%
- Corn Silage: 40% - 76% • Alfalfa: 8% - 75%

**MOST
ACCURATE
HAY PROBE
AVAILABLE**



Hay Core Sampler

77700-10676

- Professional hay core sampling equipment for farmers, sellers, and producers
- Zip-lock bag attaches to the protective metal shield allowing collection of up to 20 samples with no mess or contamination
 - The inside diameter of the shaft is 7/8" allowing samples to stay loose for easy bagging with the cleanout rod between samplings
 - Includes cleanout rod for pushing hay into provided zip-lock sample bag
 - Shaft and connections are made of stainless steel
 - Sampling depth is 20"
 - Sampler can be used with either a 3/8" or 1/2" drill



Windrow Hay Moisture Tester

77700-10677

- Only portable hay moisture tester available for use in the field before baling
- Quickly measures loose hay and forage from a windrow without committing the time and expense of using baling or chopping equipment before the hay is at the correct moisture levels
- Simple to use - add loose hay to a five-gallon bucket, insert tester probe and press a button
- Moisture range: 13% - 70% depending on hay tested
- Testing time: 30 - 60 seconds
- Accuracy: +- 2% - 4%
- Display resolution: 0.1% moisture
- 9V battery required



Sprayers & Moisture Testers

Ag-MAC™ Plus Grain Moisture Tester with Test Weight

77700-10679

- Direct readout for 20 different grain scales
- Displays grain test weight (no pre-weighing)
- Measures moisture fast, easy, and accurately
- Non-compaction design with LCD display
- USB compatibility for updates of grain scales and firmware
- Automatic temperature compensation
- Hot corn up to 160° F (71° C)



Soil Compaction Tester

77700-10678

- Increases crop yield by measuring the extent and depth of soil compaction
- 24" stainless steel rod with adjustable shock collar to prevent damage
- Easy-to-read, color-coded, stainless steel dial that is liquid filled to reduce shock
- Durable molded housing with rubber grips
- Large and small tip included with convenient storage in tester housing
- Easy to store on wall or above workbench

MT-PRO Grain Moisture Tester

77700-06330

- Direct readout for 40 different grain scales
- Tests high moisture grain up to 40 percent
- Single-point or precision multi-point calibration to match local elevator
- Built-in average button displays the average of saved test results
- Higher-frequency, capacitive circuit for greater accuracy
- Includes protective carrying case with shoulder strap



DHT-1 Hay Moisture Tester with 18" Probe

77700-06328

- Direct readout for moisture % and temperature (°F and °C)
- Extra-rugged probe shaft made from aircraft aluminum
- Accurate throughout the normal range of stored, baled hay
- Moisture range: 14% - 44% depending on hay tested
- 9V battery required



HT-PRO Hay Moisture Tester with 20" Probe

77700-06327

- Includes calibration clip—less than 20 seconds to calibrate
- Above and below moisture limit indication
- Illuminated LCD display
- Moisture range: 8% - 44% depending on hay tested
- 9V battery required
- The first and only portable hay moisture tester with a calibration clip



MOISTURE TESTERS

BHT-2 Advanced Baler-Mounted Hay Moisture Tester

77700-13399

- Bale type: small square bales and round bales
- New multi-sensor technology takes readings on the left and right side, as well as through the bale, for greater accuracy
- Large LCD display for easy viewing during day or night
- Illuminated keypad and display
- \pm Moisture offset adjustments
- User can set the high and low limit of the moisture reading. Buzzer will sound if high or low limit is exceeded.
- Software upgradable via standard USB cable (included)



49" Bale Spear Kit

NEW

77700-13398

- Build a new hay mover or replace old spear with this kit
- Rated for 3,500 lbs.
- Kit includes: 1 Hay Spear, 1 Tapered Nut, 1 Tapered Bushing



KEEP IT GENUINE. KEEP IT **KUBOTA!**

ARE YOU MARKETING FOR KUBOTA GENUINE PARTS?



Kubota Parts and Service
Reliability for the Job Ahead

