



Kubota

2024 CONSTRUCTION BROCHURE



COMPANY PROFILE

HARD-WORKING KUBOTA TOOLS TO HELP YOU GET MORE DONE

For more than 50 years, Kubota has been your partner in pursuit of your property dreams.

As a do-it-yourselfer, you count on hard-working tools to help you get more done every day. And, like you, Kubota believes anything worth doing is worth doing right.

Whether you manage a two-acre yard or 2,000-acre ranch, hay field or construction site, our precision engineered orange equipment helps you conquer your goals one project at a time.

The entire Kubota product line – from utility vehicles and mowers, to tractors, hay tools and a full range of construction equipment – is quality built to keep you growing and improving your property, your business, and your community for years to come.

This brochure is a comprehensive look at our entire line and all the hard-working tools ready to help you get more done. Check out our recent innovations, new market entries, and products you likely already know well. We are constantly evolving to expand our products to better meet your needs for today and well into the future.

For more ideas to help you get more done, visit our website at KubotaUSA.com.



Kubota



TABLE OF CONTENTS

STAND-ON COMPACT LOADERS

2 SCL1000 Series

SKID STEER LOADERS

6 SSV Series

COMPACT TRACK LOADERS

8 SVL Series

12 SSV and SVL Series Accessories & Attachments

COMPACT EXCAVATORS

30 KX Series

34 U Series

36 KX and U Series Accessories & Attachments

WHEEL LOADERS

44 R Series

TRACTOR LOADERS AND LANDSCAPERS

46 TLB Series

UTILITY VEHICLES

48 RTV-X Series

KUBOTA SERVICES

56 Kubota Services





SCL1000

Compact in size, packed with performance, Kubota's Stand-on Compact Loader conquers the toughest of tasks yet is nimble enough to get in tight spaces.

- › 24.8 HP turbo charged Kubota engine provides quiet operation, high altitude performance and requires no DPF
- › Vertical lift loader arms reach higher and further than the competition with a hinge pin height of 84.7" and a reach of 26" (at 45° dump angle).
- › 1000 lbs. ROC combined with 15 gpm auxiliary hydraulic flow make for a powerful and productive compact utility loader
- › 4.3" Color LCD monitor includes Keyless start with passcode protection and easy to read consolidated machine monitoring with service reminders. A convenient 12 volt charging port is also standard
- › The patented T-drive handle provides intuitive and ergonomic steering. Hydraulic pilot-operated loader and drive control valves offer precise and responsive control of the machine
- › Right hand joystick controls loader arm and bucket movement. Auxiliary hydraulics are easily operated without removing your hand from the loader joystick. Continuous flow in either direction is as simple as pushing a button
- › Easy to access centralized filters and everyday maintenance items. Dash indicator light alerts when the air filter needs cleaned, and service information is readily available at the touch of a button
- › Heavy-duty cast CII coupler and protective cover for bucket cylinder fittings. CII coupler is standard. Optional welded 2-lever style coupler
- › Works in zero clearance yards with low impact wide track design (4.0 psi) minimizing damage to grass or landscaping with 4.9 mph travel speed
- › Auxiliary hydraulic lines are routed inside the loader arm for optimal protection. Case drain is standard. Auxiliary hydraulic couplers are pressurized



STAND-ON COMPACT LOADER

ENGINE	
Engine Type	Water cooled 4 cycle diesel engine with 3 cylinder, turbo, EPA Tier 4
Model Name	KUBOTA D902-T
Total Displacement)	54.8 cu.in. (898 cm ³)
Engine Power - SAE J1995 Gross	24.8 HP (18.5 kW/rpm)
Rated Speed	2,800 rpm
Low Idling Speed	1,250 rpm
DIMENSIONS	
Overall Length - Transport (w/Std Bucket Parallel to Ground)	107.7" (2.74 m)
Overall Length (w/o Bucket)	84.9" (2.16 m)
Overall Height	55.7" (1.41 m)
Overall Width w/Std Bucket	36" (91.44 cm)
Operating Weight (w/o Operator) lbs	3,035 (1,376 kg)
Rated Operating Capacity (35%)	1,000 lb (453 kg) ROC
Tipping Load	2,857 lbs (1,296 kg)
Wheelbase	40.5" (1.03 m)
Hinge Pin Height at Max. Lift	84.7" (2.15 m)
Reach at Max. Lift and 45° Dump	26" (66 cm)
Track Width	9.8" (24.9 cm)
Ground Clearance	7.4" (18.8 cm)
Angle of Departure	25.2°
PERFORMANCE	
Attachment Mounting System	CI (Common Industry Interface) or 2 Lever Quick-Attach
Travel Speed (Fwd/Rev)	4.9 mph (7.9 km/h)
Ground Pressure (with Operator)	4.0 psi, 28.0 kPa (0.28 kgf/cm ²)
Battery Capacity	12V, RC 80, 540 CCA
Auxiliary Hydraulic Flow	15 gal/min (56.7812 L/min)
Auxiliary Hydraulic Pressure	2,800 psi (19.3 mPa) (196.8 kgf/cm ²)
SERVICE & FILL CAPACITIES	
Fuel Tank Capacity	7.75 gal (29.3 L)
Hydraulic System	6 gal (22.7 L)



COMPACT ATTACHMENTS



CGC1040 CLAW GRAPPLE

- » 5/16" Tine thickness
- » AR400 Steel
- » 32" Jaw opening
- » 40" Wide
- » Greaseable pivot points

The CGC10 is a compact grapple designed specifically for the Kubota SCL1000. To preserve the loader lift capacity, this compact grapple is manufactured from high-tensile AR400 steel, making it strong, yet light.

AVAILABLE FOR: SCL1000



CL136L / CL236L / CL142L / CL242L BUCKETS

- » CL136L / CL142L Standard 36" or 42" Bucket:
 - Available with bare edge, bolt-on edge or bolt-on teeth
 - CII hitch
- » CL236L / CL242L Standard 36" or 42" Bucket:
 - Available with bare edge, bolt-on edge or bolt-on teeth
 - Two lever Quick-Attach
- » CL148H High Capacity 48" Bucket:
 - Available with bare edge, bolt-on edge or bolt-on teeth
 - CII hitch

AVAILABLE FOR: SCL1000



CSR1048 POWERED RAKE

- » 48" Working width
- » Heavy-duty CII hitch
- » Tubeless tires with sealant
- » Stud roller angles 25° left or right
- » Easy, adjustable manual or hydraulic angling
- » Center pivot allows narrow width access
- » Side plates can angle

The CSR10 makes seedbed prep a breeze and is at home in a landscape setting or on a construction site.

AVAILABLE FOR: SCL1000



CPF1236 / CPF1242 PALLET FORKS

- » 36" & 42" Fork lengths
- » 1,200 lb. Capacity
- » CII hitch
- » Spill guard
- » Adjustable fork width with spring-loaded toggle to lock in place

The CPF12 helps contractors and material handlers in a variety of industries efficiently move loads from trailers, flatbeds, or racking.

AVAILABLE FOR: SCL1000

CTR1030 / CTR1036 / CTR1048 TRENCHERS



- » 30", 36", 48" Trenching depths
- » 2 Motors; high speed or high torque
- » Positive manual chain tensioner
- » Heavy-duty hitch plate
- » Chain widths on 30"/36" units: 4", 6", 8" & 10"
- » Chain widths on 48" unit: 4" & 6"
- » 3 Chain styles

Designed for efficient digging of trenches and ideal for irrigation or utility contractors, or as a rental tool.

AVAILABLE FOR: SCL1000

CSA10 SKID AUGER



- » 10-20 gpm
- » 2" Hex drive
- » 6"-24" Dirt augers
- » 6"-12" Rock augers
- » Pendulum mount

Landscapers and contractors will find the CSA10 is a durable tool for digging holes for footings, fences, signs, or trees.

AVAILABLE FOR: SCL1000

BR360 / BR460 BREAKERS



- » Multiple tool options
- » Wear resistant steel housing
- » Replaceable seal and bushing
- » CBE: Constant blow energy
- » Performance matched to SCL1000 for optimum efficiency

Ideal for demolition of concrete and rock, and as a rental tool where optimum power and breaking efficiency is required

AVAILABLE FOR: SCL1000



SSV Compact Skid Steer Loaders

SSV65 | SSV75

Greater power now comes in a smaller package. Our SSV skid steer loader is easier to transport from site to site and easier to maneuver in tight spaces.

- › Increase operator comfort in our roomy fatigue- and stress-reducing cabin, encouraging all-day alertness
- › The sliding front entry door can be opened or closed regardless of loader position
- › Cabin has an optimized air conditioning and climate control system for all-year-round operator comfort
- › Move more material faster in applications such as agriculture, construction, and landscaping
- › An optional multi-function lever allows fingertip control of all major vehicle and implement operations
- › The closed cab is radio-ready with speakers, wiring, and antenna standard equipment
- › Flip a switch on the hydraulic quick coupler to hook up or remove attachments without leaving your seat
- › Discover the increased lifting capacity, higher lift heights, and overall higher productivity of the SSV Series



SKID STEER LOADERS

Skid Steer Loaders

	SSV65	SSV75
Operator Station	Open cab / Closed cab	
Operating Weight (lbs.) (inc. operator weight 175 lbs.)	6,790 / 7,055	8,157 / 8,422
ENGINE		
Model	V2607-CR-TE4	V3307-CR-TE4
Emission Certification	Tier 4	
Gross HP (hp/rpm)*	64/2,700	74.3/2,600
Displacement (cu. in.)	159.7	203.3
Cylinders	4	
Bore Stroke	3.5 x 4.4"	3.8 x 4.8"
Aspiration	Turbocharged	
LOADER PERFORMANCE		
Rated Operating Capacity 50% Tipping Load (lbs.)	1,950	2,690
Tipping Load (lbs.)	3,900	5,380
Breakout Force – Bucket (lbf.)	4,839	5,884
Breakout Force – Lift Arm (lbf.)	3,858	4,850
Lift Arm Path	Vertical	
UNDERCARRIAGE		
Standard Tire Size	10-16.5-8PR	12-16.5-10PR
Chain Size ASA#	80	100
Travel Speed – Low (mph)	6.9	7.4
Travel Speed – High (mph)	11.1	11.8
Traction Force (lbf)	7,339	8,494
Ground Clearance	7.6"	8.1"
HYDRAULIC SYSTEM		
Loader Hydraulic Pressure (psi)	3271	
Aux. Hydraulic Flow (standard/high) (gpm)	18.0 / 28.0	20.9 / 30.4
Hydraulic Tank (gal.)	4.2	
Fuel Tank (gal.)	25.4	26.9



* SAE J1995



SVL Compact Track Loaders SVL65-2 | *NEW Model SVL75-3* | SVL97-2

The SVL Series provides powerful breakout force and lifting capacity for groundbreaking new levels of performance and productivity.

- › Powered by 4-cylinder Kubota CRS-TE4 turbocharged engines with 68.3, 74.3 and 96.4 horsepower, these engines are equipped with common rail fuel injection and diesel particulate filters
- › Vertical lift design and low center of gravity deliver exceptional stability
- › Standard-equipped 2-speed travel and high ground clearance helps ensure excellent travel performance on difficult terrains
- › Comfortable and spacious cab area features a luxurious, adjustable full-suspension seat and plenty of legroom
- › Angled track frame cover helps to prevent soil from accumulating during operation
- › Easy maintenance features include a large engine compartment door to access all components for daily routine checks
- › Choose an optional high flow system on the SVL65-2 or SVL75-3 and take productivity to a new level. When choosing a SVL97-2 with an optional high flow system, utilize the variable hydraulic flow function to dial in your hydraulic flow for maximum hydraulic attachment performance

SVL97-2

- › KubotaNOW Telematics (Standard)
- › Rearview camera (Standard)



COMPACT TRACK LOADERS

Compact Track Loaders

	SVL65-2	SVL75-3	SVL97-2
Engine Type (Kubota, liquid-cooled, diesel)	V2607-CR-TE4 turbocharged 4-cylinder	V3307-TE5A turbocharged 4-Cylinder	V3800 CRS-TE4 turbocharged 4-cylinder
Horsepower (gross)*	68.3	74.3	96.4
Displacement (cu. in.)	159.6	203.3	230
Overall Length (w/ bucket on the ground)	136.4"	142.1"	154.6"
Overall Height (top of cab)	79.9"	81.8"	83.3"
Overall Width (w/ bucket)	68" / 74"	68"	80"
Operating Weight (lbs.) (ROPS/cab)	8,135 (3,690) / 8,631 (3,915)	9,190 / 9,420	11,277 (5,115) / 11,552 (5,240)
Operator Station		Open cab / Closed cab	
LOADER PERFORMANCE			
Rated Operating Capacity (ROC) 35% Tipping Load (lbs.)	2,100	2,490	3,200
Tipping Load (lbs.)	6,000	7,112	9,143
Breakout Force – Bucket (lbf.)	4,614	6,191	7,623 (3,458)
Breakout Force – Lift Arm (lbf.)	4,266	4,723	5,530
Lift Arm Path		Vertical	
UNDERCARRIAGE			
Track Width (standard/wide)	12.6" / 15"	12.6" / 15.8"	17.7"
Ground Pressure (psi) (standard/wide)	5.0 / 4.4	5.8 / 5.9	4.4
Track Rollers (per side)	4	4	5
Track Ground Contact Length	57.9"	56.5"	65.6"
Travel Speed (mph) (low/high)	4.9 / 7.1	5.6 / 8.6	5.0 / 7.3
Traction Force (lbs.)	8,406	9,678	12,178
Minimum Ground Clearance	9.1"	11.7"	11.5"
AUXILIARY HYDRAULIC POWER			
Aux. Hydraulic Pressure (psi)	3,263	3,185	3,553
Aux. Hydraulic Flow (gpm) (standard/high)	17.4 / 27.0	19.2 / 29.8	23.1 / 40

* SAE J1995

SVL SERIES





COMPACT TRACK LOADERS

ADDITIONAL LOADER ATTACHMENTS

	SSV65	SSV75	SVL65-2	SVL75-3	SVL97-2
Standard and Heavy-Duty Buckets	68", 74"	74"	68", 74"	68", 74"	80", 84"
4-in-1 Bucket	68", 74"	74", 80"	66", 72"	68", 74"	80", 84"
Rock Bucket	66", 72", 78"				78"
Utility Stump Bucket	72", 78"				
Pallet Forks	48", 60"				
Tilt Hitch	Available for all SSVs / SVLs				
Skid Steer 3 pt Hitch	Available for all SSVs / SVLs				
Grapple – Claw		72"		72", 84"	84"
Grapple – Rock	68", 72", 78"				78"
Scrap Grapple	68", 72", 78"				
Root Grapple	68", 74"				80"
6-Way Dozer Blade		84"		84", 96"	
Trencher	48", 60"				
Post Hole Digger	Two models available up to 30 gpm				
Tree Auger	24", 30", 36"				
Rock Auger	6", 9", 12", 15", 18", 24"				
Box Blade	84", 96"				
Concrete Claw	Available for all SSV's and SVL's				
Hydraulic Hammer	500 energy class				750 energy class
Loader Boom JIB	6000 lb capacity				
Angle Broom	72", 84"				84"
Hopper Broom	74", 84"				84"
Soil Conditioner (Power Rake)	72"				90"
Skid Grader	72", 84"				
Rotary Cutter (2" & 4" Cap.)	60", 72"				
Rotary Cutter (6" Cap.)	N/A				72"
Rotary Cutter (7" Cap.)	N/A				72"
Rotary Tiller	62", 76"				
Stump Grinder	24"				
Tree Pullers	15 Series	25 Series			
Snow Pusher	84", 96"				
Snow Trip Edge Blade	96", 108"				
Snow Blower	66", 74"	66", 74", 84"	66", 74"	66", 74", 84"	84"
Snow/Light Material Bucket	84", 96", 108"				
Cold Planer	18", 24", 30"				18", 24", 30", 40", 48"
Road Saw	10"				10", 18"
Primary Seeder	74", 86"				
Ripper	5 Shank Ripper				



There's an attachment for that!

Two machines with many uses. If there's a job, then there's a specialized SSV or SVL attachment that can handle it. Whether it's a pile of dirt, debris and rocks, or a pile of snow, you can customize your Kubota to haul, cut, grapple, load, grind, drill, and till. And, once the heavy work is done, you can rake the ground smooth again.

BUCKETS / MATERIAL HANDLING

Realize the full potential of your Kubota Skid Steer Loader or Compact Track Loader with an ever-expanding array of versatile bucket attachments and pallet forks. Each one will help you save loads of time and effort in a multitude of efficient ways.



STANDARD DUTY BUCKETS

All buckets have side cutters and cutting edges or welded teeth. They come in two profiles, Standard Floor (SF) or Long Floor (LF), and in widths of 68" and 74". Standard Duty Buckets are recommended for most skid steer applications including agricultural, landscaping, and some construction applications.

AVAILABLE FOR: SSV65 / SSV75



HEAVY DUTY BUCKETS



Available in widths of 68", 74", 80" and 84" these buckets are the buckets of choice for traction force and applications of our compact track loaders. For our skid steers, the 68" and 74" heavy duty buckets are ideal when working in heavy duty applications including concrete work, heavy and predominant excavation, mining, and recycling.

AVAILABLE FOR: SSV65 / SSV75 / SVL65-2 / SVL75-3 / SVL97-2

CB25 COMBINATION BUCKETS

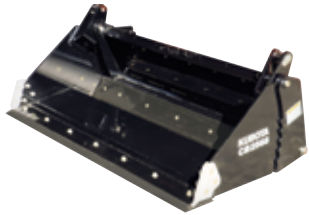

- » 68" (996 lbs), 74" (1056 lbs), 80" (1147 lbs)
- » Dual cutting edge on jaw
- » Bolt-on edge on back blade
- » Cylinder protection
- » Optional counterbalance valve
- » Struck cap. 10–16 cu. ft.; Heaped cap. 15–22 cu. ft.

Concrete contractors, landscapers, dirt contractors, and farmers can perform grapple, dozer blade, bucket, and back drag actions with the CB25.

AVAILABLE FOR: SSV65 / SSV75 / SVL65-2 / SVL75-3 / SVL97-2

CB35 COMBINATION BUCKETS



- » Strength and rigidity to the bucket, jaws, and dozer features of the four-in-one bucket.
- » Reversible blades extend the life of the blade and can be replaced to extend the life of the bucket.
- » Can be used as a standard bucket, grading tool, grapple, or dozer.
- » Various sizes, shapes, and weights of objects can be picked-up and held securely in the serrated teeth.

AVAILABLE FOR: SSV65 / SSV75 / SVL65-2 / SVL75-3 / SVL97-2

SRB15 ROCK BUCKETS



- » 66" (509 lbs), 72" (550 lbs), 78" (594 lbs)
- » 3" Teeth spacing
- » 3/8" Tooth thickness
- » Grade 80 steel tine material
- » 38" Working length

The SGR15 Rock Bucket is designed to do the dirty work, moving volumes of material quickly and efficiently.

AVAILABLE FOR: SSV65 / SSV75 / SVL65-2 / SVL75-3 / SVL97-2

SIDE CUTTER REPLACEMENT KIT

(Left and Right - fits all 68", 74", 80" and 84" Buckets)

These Bolt-On Side Cutters (BOSC) greatly extend bucket service life and improve penetration power into hard-packed soil or stockpiled materials. BOSC's are a standard feature on Kubota's buckets and their major purpose is to extend service life of the bucket corners and reduce downtime for costly rebuilds.

AVAILABLE FOR: SSV65 / SSV75 / SVL65-2 / SVL75-3 / SVL97-2





TH35 TILT HITCH

- » 20 degree tilt in either direction
- » Angle gauge and level - standard
- » Nylon slide pads
- » Tilts buckets and other attachments to help contractors, landscapers and homeowners with grading and leveling

AVAILABLE FOR: SSV65 / SSV75 / SVL65-2 / SVL75-3 / SVL97-2



PFL46 & PFL56 PALLET FORKS

- » PFL45: 48" (422 lbs), PFL55: 48" (446 lbs), 60" (492 lbs)
- » Forks adjust to 4" spacing
- » Spring loaded toggle fork position lock
- » Wide frame with step
- » Removable top center bracket

Useful for landscaping, farming, ranching, construction, nurseries, campuses, theme parks, salvage operations, warehouses, lumber yards, retail outlets, and more.

AVAILABLE FOR: SSV65 / SSV75 / SVL65-2 / SVL75-3 / SVL97-2



SH35 SKID STEER HITCH

- » Fits Cat. 1 or 2 implements
- » Adjustable top hook
- » Universal skid plate
- » Built in 2" receiver hitch
- » Automatic locking

Quickly and easily attach to Cat. 1 or 2 implements that are not PTO-driven such as box scrapers, landscape rakes, and soil pulverizers.

AVAILABLE FOR: SSV65 / SSV75 / SVL65-2 / SVL75-3 / SVL97-2



PS20 PRIMARY SEEDER

- » 72" or 86" Widths
- » Bi-directional seed cups
- » Quick attach mount and 3-point hitch standard
- » Large capacity seed box
- » Floating packer wheels to follow the contours
- » Patent Pending

Ideal for landscapers, contractors, and rental yards. No need to take another power unit to the site when you go to put on the finishing touches.

AVAILABLE FOR: SSV65 / SSV75 / SVL65-2 / SVL75-3 / SVL97-2



CP30 COLD PLANERS



- » 12", 16", 18", 24", 30", 40", 48" Widths
- » CP30: 0-6" Cutting depth
- » Independent RH/LH skid shoe control
- » Hydraulic tilt, depth, and sideshift
- » Optional water system
- » Removable cutting teeth
- » 3 Line set up (pressure, return and case drain)

Ideal for road contractors, municipalities, and rental yards for milling asphalt, cutting utility trenches, pothole/shoulder repairs.

AVAILABLE FOR: SSV65 / SSV75 / SVL65-2 / SVL75-3 / SVL97-2

HB HOPPER BROOM



- » 74" or 84" Widths
- » Heavy-duty bucket design - 3/16" shell
- » Bucket tapered front to back to hold material in
- » 26" Replaceable brushes
- » Tool-less height adjustment
- » Heavy-duty metal top with bump protection

This large tapered heavy-duty collection bucket offers multiple brush configurations making it the perfect construction site clean-up tool for contractors and rental yards.

AVAILABLE FOR: SSV65 / SSV75 / SVL65-2 / SVL75-3 / SVL97-2

SW30 ROAD SAW



- » Electric or hydraulic control of tilt, sideshift and depth
- » Either 10" or 18" depth of cut
- » 2.5" - 6" Widths
- » Multiple tooth options available

Ideal for road contractors, municipalities, and rental yards for milling asphalt, cutting utility trenches, pothole/shoulder repair.

AVAILABLE FOR: SSV65 / SSV75 / SVL65-2 / SVL75-3 / SVL97-2

RP30 RIPPER



- » 5 Shank design with replaceable tips
- » Skid shoes
- » Level indicator

Contractors and landscapers can rip or loosen dirt, sand, and tailings at varying depths. Using this unit in between compaction passes will also help achieve the desired compaction rating.

AVAILABLE FOR: SSV65 / SSV75 / SVL65-2 / SVL75-3 / SVL97-2



BR BREAKERS

- » BR310, BR360, BR460, BR510, BR560, BR860
- » Multiple tool options
- » Wear resistant steel housing
- » Replaceable bottom plate

Ideal for demolition, frozen ground and rental yards where optimum power and breaking efficiency is required.

AVAILABLE FOR: SSV65 / SSV75 / SVL65-2 / SVL75-3 / SVL97-2
KX018-4 / KX71 / KX033 / KX040 / KX057 / KX080
U17 / U27 / U35 / U55

GRAPPLES

No matter how gnarly or oddly shaped the load gets, there's an SSV or SVL that can get a grip on it. Rubble and brush are no match for Kubota's standard equalizer valve, which ensures equal clamping force across the entire grapple surface.



SGC20 CLAW GRAPPLES

- » 72" (895 lbs), 84" (999 lbs)
- » 6" Teeth spacing
- » 1/2" Tooth thickness
- » High tensile AR400 steel
- » 6" x 6" Frame tube

Claw Grapples make quick work of large jobs, and can be used to rake, dig, and move rocks, trees, brush, and construction debris without picking up dirt.

AVAILABLE FOR: SSV65 / SSV75 / SVL65-2 / SVL75-3 / SVL97-2



SGR15 ROCK GRAPPLES

- » 66" (889 lbs), 72" (938 lbs), 78" (972 lbs)
- » 3" Teeth spacing
- » 3/8" Tooth thickness
- » Grade 80 steel tine material
- » 37" Jaw opening

The Rock Grapple features 3" spacing between the teeth allowing small rocks, soil, and debris to be sifted, leaving the larger material locked in its jaw.

AVAILABLE FOR: SSV65 / SSV75 / SVL65-2 / SVL75-3 / SVL97-2



GB30 SCRAP GRAPPLE BUCKETS

- » 68" (1195 lbs), 74" (1251 lbs), 80" (1337 lbs)
- » 1/4" Two-piece shell
- » 1/2" End panels
- » Five bottom wear bars
- » 3/4" Grapple tines
- » Hard hydraulic lines

Demolition crews, recycling plants, municipalities, junk yards, and rental yards can retain debris until it is piled or loaded.

AVAILABLE FOR: SSV65 / SSV75 / SVL65-2 / SVL75-3 / SVL97-2



RG30 ROOT GRAPPLES



- » 68" (1058 lbs), 74" (1074 lbs), 80" (1170 lbs)
- » Gusseted 1/2" frame tines
- » 3/4" Thick grapple tines
- » Greaseable pivot points
- » Wide tine spacing
- » Hard hydraulic lines

Farmers, landscapers, nurseries, construction crews, tree services, and rental fleets are able to pick up large debris off of the ground, while separating out dirt and other small material.

AVAILABLE FOR: SSV65 / SSV75 / SVL65-2 / SVL75-3 / SVL97-2

BB30 BOX BLADE



- » 72", 84", 96" Widths
- » Bi-directional with hinged cutting edge
- » Floating front axle
- » Replaceable side plates with adjustable skid shoes
- » Lift/tilt with parallel links standard
- » Ability to accept attachment control system

AVAILABLE FOR: SSV65 / SSV75 / SVL65-2 / SVL75-3 / SVL97-2

CC30 CONCRETE CLAW



- » 3/4" Side plates
- » 1/2" Floor pan
- » Long floor for more leverage
- » 3 Replaceable teeth

AVAILABLE FOR: SSV65 / SSV75 / SVL65-2 / SVL75-3 / SVL97-2

MULTI-USE ATTACHMENTS

Kubota's SSV and SVL multi-use attachments are designed to extend the near-limitless versatility of your machine. These attachments can be used on any job site by a wide variety of industry professionals.



DZ30 6-WAY DOZER BLADES

- » 84" (1345 lbs), 96" (1440 lbs)
- » 3/8" Moldboard w/ full boxed bracing
- » 3/4" x 8" Reversible cutting edge – 3 piece design
- » 3" Pivot pins
- » 3-1/2" x 8" Welded cylinders
- » 1/2" x 4" Full length wear bar

Preparing rough grade, moving material around the job site, pushing silage or manure, cutting or clearing ditches.

AVAILABLE FOR: SSV65 / SSV75 / SVL65-2 / SVL75-3 / SVL97-2



TR TRENCHERS

- » 48" (858 lbs), 60" (886 lbs)
- » Adjustable auger
- » 15-24 gpm, 25-40 gpm Motor options
- » Manual or hydraulic sideshift
- » 6" - 10" Width chain options
- » Patented depth gauge

Used by rental yards, contractors and developers to dig trenches for water, electrical, drainage or footings in many different soil conditions.

AVAILABLE FOR: SSV65 / SSV75 / SVL65-2 / SVL75-3 / SVL97-2



SA20 SKID AUGER

- » 10-30 gpm; 2 Motor options
- » Weight: 244 lbs
- » 6" - 36" Diameter augers
- » 2" Hex output shaft
- » Center and 18" offset mount to the right
- » Planetary gearbox

The SA20 is ideal for nurseries, landscapers, contractors, construction companies, farmers, ranchers, and municipalities.

AVAILABLE FOR: SSV65 / SSV75 / SVL65-2 / SVL75-3 / SVL97-2



SA35 SKID AUGER

- » 15-25 gpm
- » Weight: 362 lbs
- » 9" - 36" Diameter augers
- » 2" Hex or 2-9/16" round output shaft
- » Planetary gearbox

The SA35 meets the industrial duty applications of nurseries, landscapers, contractors, construction companies, farmers, ranchers, and municipalities. The 36" auger is perfect for planting ball rooted trees.

AVAILABLE FOR: SSV65 / SSV75 / SVL65-2 / SVL75-3 / SVL97-2



ROCK AUGERS

- » 3.5" High strength tube
- » 3/4" Double flight bore head
- » Bullet style carbide tips
- » 1-3/4" Square shanked pilot
- » 6", 9", 12", 15", 18" & 24"

AVAILABLE FOR: SSV65 / SSV75 / SVL65-2 / SVL75-3 / SVL97-2

REQUIRES: SA20 OR SA35



BOLT-ON ROCK HEADS

- » Mount to any existing Aggressor auger
- » Carbide bullet teeth
- » Pilot bit w/teeth
- » Wear caps for leading edge of flights
- » 6", 9", 12", 15", 18" & 24"

AVAILABLE FOR: SSV65 / SSV75 / SVL65-2 / SVL75-3 / SVL97-2

REQUIRES: SA20 OR SA35



LB60 LOADER BOOM

- » Weight: 395 lbs
- » 6" x 6" Tube construction
- » 6,000 lbs. Lift capacity
- » Flat front
- » Two 1" lifting lugs
- » Stabilizer chain connections / side plates

Provides a stable lifting platform for placing and removing concrete forms, and transplanting trees and shrubs.

AVAILABLE FOR: SSV65 / SSV75 / SVL65-2 / SVL75-3 / SVL97-2



AB ANGLE BROOMS

- » 72" (865 lbs), 84" (884 lbs)
- » Hydraulic range: 12-30 gpm
- » Brush speed: 100-230 rpm
- » 32" Brush diameter
- » Replaceable hex drive system
- » Poly, wire, or combination bristles
- » Optional dust suppression system with 25 gallon tank

Angle Brooms are ideal for construction site cleanup, road maintenance, light snow removal on paved surfaces, and cart path maintenance.

AVAILABLE FOR: SSV65 / SSV75 / SVL65-2 / SVL75-3 / SVL97-2

LANDSCAPE ATTACHMENTS

Tame the wild with landscape attachments that are specifically engineered to make the SSV and SVL perfect machines for any municipal and commercial landscaper. If nature can grow it, then there's a landscaping attachment to chop, grind, pull, rake, and till it down to size.

SRT25 SKID TILLERS



- » 62" (785 lbs), 76" (880 lbs)
- » 14-42 gpm
- » Case drain protection
- » Ripper shanks
- » Forward or reverse rotation
- » Spiral rotor design with C-shaped bidirectional tines

Forward and reverse rotation tillers are great for seedbed or garden plot soil preparation used in landscaping, nurseries, gardens, and light commercial applications.

AVAILABLE FOR: SSV65 / SSV75 / SVL65-2 / SVL75-3 / SVL97-2

SR27 POWERED RAKES



- » 72" (766 lbs): 12-19 gpm / 90" (1162 lbs): 15-23 gpm
- » Rigid or float option
- » Manual or hydraulic angle
- » Cast chain housing
- » Larger U-bolts on gauge wheel

Landscapers, nurseries, rental yards, and housing contractors can prep and level ground for seeding, remove unwanted material and debris, and rejuvenate driveways and gravel lots.

AVAILABLE FOR: SSV65 / SSV75 / SVL65-2 / SVL75-3 / SVL97-2

SC25 SKID CUTTERS

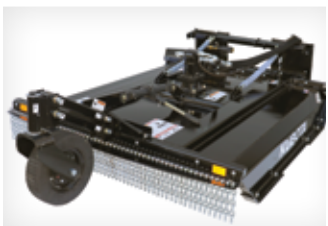

- » 60" (1098 lbs), 72" (1350 lbs); 15-25 gpm
- » 2" Diameter cut capacity
- » 1-1/2" - 18" Cutting height; infinitely variable
- » 10 Gauge steel deck; 1/4" side skirt

Ideal for tightly restricted areas under fences, in and around boxed in corner sections of corrals and out buildings, vineyard, nursery rows, wooded lots, and approaches to ditches and waterways.

AVAILABLE FOR: SSV65 / SSV75 / SVL65-2 / SVL75-3 / SVL97-2

SC40 SKID CUTTERS



- » 60" (1356 lbs), 72" (1718 lbs)
- » Motor options: 15-25 gpm and 26-43 gpm
- » 4" Diameter cut capacity
- » 1/4" Deck thickness
- » Pressure gauge
- » Tapered full length skid shoes
- » Inline bearing

Farmers/ranchers, developers, contractors, and rental yards can clear land or small trees, shrubs, bushes and grass.

AVAILABLE FOR: SSV65 / SSV75 / SVL65-2 / SVL75-3 / SVL97-2



SC60 SKID CUTTER



- » 18-30 gpm
- » 72" Width
- » 6" Cutting capacity
- » 1/4" Deck thickness
- » Single plate blade carrier
- » Replaceable carbide teeth on bottom of carrier
- » Patent pending retractable door
- » Wide angled full length skid shoes

AVAILABLE FOR: SSV75 / SVL75-3 / SVL97-2

SC70 SKID CUTTER



- » 72" (2456 lbs)
- » 7" Diameter cut capacity
- » 4 Swinging blades, reversible
- » Retractable front door
- » Replaceable carbide teeth on bottom of blade carrier
- » Wide, angled full length skid shoes

Farmers/ranchers, developers, contractors, and rental yards can clear land or small trees, shrubs, bushes and grass.

AVAILABLE FOR: SVL97-2

SG25 SKID GRADERS



- » 72" (886 lbs), 84" (952 lbs)
- » Standard ripper teeth
- » Bidirectional blades; Adjustable cutting angles
- » Replaceable skid shoes
- » Correct hitch angle
- » Bucket carrier on top

Landscapers, contractors, homeowners, rental yards, and developers can level construction sites, or for seed preparation and rejuvenating driveways and parking lots.

AVAILABLE FOR: SSV65 / SSV75 / SVL65-2 / SVL75-3 / SVL97-2

SSG20 STUMP GRINDER



- » Increase cut-rate capabilities by increasing the tension on the attachment's extension spring.
- » Continuous maximum hydraulic flow up to 21 gpm (79 Lpm), the SSG2024 Stump
- » Grinder can efficiently grind down tree stumps with high wood density. With a continuous maximum hydraulic flow up to 21 gpm (79 Lpm), the SSG2024 Stump
- » Allows the operator to efficiently grind down tree stumps, large and small.

Compatible with a multitude of power machines, including excavators, skid steers, track loaders & compact utility loaders. The versatility this attachment provides also makes it an option to access hard-to-reach tree stumps.

AVAILABLE FOR: SSV65 / SSV75 / SVL65-2 / SVL75-3 / SVL97-2

SSG25 STUMP GRINDER



- » 17-32 gpm; 1100 rpm
- » Weight: 540 lbs
- » 24" Diameter cutting wheel
- » Maximum cutting arc of 55 degrees
- » Hydraulic motor with electric over hydraulics
- » Depth of 8" below ground
- » 1/2" Thick by 20" diameter with carbide teeth

A great choice for contractors, landscapers, and forestry departments, the SSG25 turns large stumps into small chips.

AVAILABLE FOR: SSV65 / SSV75 / SVL65-2 / SVL75-3 / SVL97-2

STP15 TREE/POST PULLER



- » 30-65 HP Machine size
- » Weight: 240 lbs
- » 10" Jaw opening
- » Laser cut saw tooth design
- » 3" x 3-1/2" Square tubing frame
- » Cylinder cover

Great for residential and small landscaper uses with moving shrubs, saplings, and small trees; pulling them from the ground, roots and all.

AVAILABLE FOR: SSV65

STP25 TREE/POST PULLER



- » Top to bottom pivot shaft
- » Weight: 416 lbs
- » Interlocking teeth on the jaws
- » Reinforced jaws
- » Shielded cylinder

Farmers/ranchers, fence builders, homeowners, recycling plants, municipalities and rental yards can use the STP25 to pull trees, bushes, poles, or posts out of the ground, leaving no root or stump to contend with.

AVAILABLE FOR: SSV65 / SSV75 / SVL65-2 / SVL75-3 / SVL97-2

UB25 UTILITY BUCKET



- » Weight: 420 lbs; Grade 50 steel
- » Replaceable digging teeth
- » Bent bottom to aide in leverage
- » Top tapered ripper teeth in side wall
- » Hardened cutting edge
- » Built in connection points for tie downs

This construction grade utility bucket acts as a shovel-like attachment for stump and small tree removal, relocating landscaping rocks or boulders, and light trenching.

AVAILABLE FOR: SSV65 / SSV75 / SVL65-2 / SVL75-3 / SVL97-2



ACCESSORIES & ATTACHMENTS CONTINUED

SNOW ATTACHMENTS

Keep travel flowing at all elevations with these Kubota snow removal attachments. Whether it's blowing snow from a park pathway or clearing a major thoroughfare, this versatile line-up of snow attachments will make safe and short work of all snowy conditions.

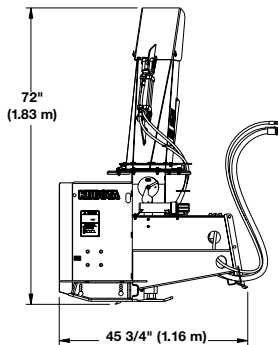
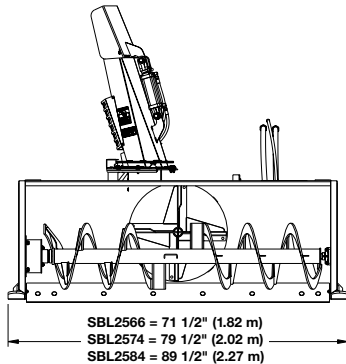

SBL25 Series Snow Blowers				
Specifications & Capacities				
		SBL2566	SBL2574	SBL2584
Working Width	in (m)	66 (1.68)	74 (1.88)	84 (2.13)
Overall Width	in (m)	71 1/2 (1.82)	79 1/2 (2.02)	89 1/2 (2.27)
Weight with outside skid shoes, case drain line, couplings, & hydraulic motor	lbs (kg)	816 (370)	938 (426)	988 (448)
Drive and Control System	Hydraulic motors with electric over hydraulic			
Hydraulic Requirements:	gpm (Lpm)	12-19 (45.4-71.9)		
Low Volume Motor Option		20-26 (75.7-98.4)		
Medium Volume Motor Option		27-33 (102.2-124.9)		
High Volume Motor Option				
Hydraulic Pressure Rating	psi (mPA)	2500-3500 (17.2-24.1)		
Hitch	Skid steer/loader mounting plate			
Main Housing Material	ga (mm)	10 (3.4)		
Side Plate Material	in (mm)	3/16 (5)		
Chute Opening at the Base	in (cm)	10 (25.4)		12 (30.5)
Impeller Housing Depth	in (cm)	8 (20.3)		10 (25.4)
Impeller Diameter	in (cm)	24 (61)		
Number of Impeller Blades		4		
Auger Diameter	in (cm)	16 (40.6)		
Number of Auger Paddles		4		
Cutting edge	Bolt-on, reversible, and replaceable full-length cutting edges			
Skid Shoes	Bolt-on, adjustable & replaceable			
Chute Rotation	220 Degrees (Hydraulically driven sprocket)			
Spout Deflector	Hydraulic operation			
Spout Deflector Cylinder	in (cm)	Double acting 2 x 4 x 1 1/2 (5.1 x 10.2 x 3.8) rod		



SBL30 & SBL35 Series Snow Blowers					
Specifications & Capacities					
		SBL3074	SBL3084	SBL3574	SBL3584
Working Width	in (cm)	74 (188)	84 (213.4)	74 (188)	84 (213.4)
Overall Width	in (cm)	82.5 (209.6)	92.5 (235)	82.5 (209.6)	92.5 (235)
Base Unit Weight	lbs (kg)	737 (334.3)	791 (358.8)	1,004 (455.4)	1,056 (479)
Hydraulic Motor Option Weight	lb (kg)	17-23 gpm = 200 (90.7) 27-33 gpm = 225 (102.1)		N/A (Included with base unit)	
Drive and Control System	Hydraulic motors with electric over hydraulic				
Hydraulic Motor Flow Rates	gpm (Lpm)	17-23 (64.4 - 87.1) Option 20 27-33 (102.2 - 124.9) Option 21		34-41 (128.7 - 155.2) Standard	
Hydraulic Pressure Rating (Max)	psi (mPA)	3,500 (24.1)			
Hitch	Skid Steer Universal Quick Attach				
Main Housing Material	ga (mm)	10 (3.4)			
Side Plate Material	in (mm)	.25 (6)			
Chute Opening at the Base	in (cm)	10 (25.4)			
Impeller Housing Depth	in (cm)	7 (17.8)			
Impeller Diameter	in (cm)	26.375 (67)			
Number of Impeller Blades		5			
Auger Diameter	in (cm)	16 (40.6)			
Cutting Edges (Steel or Poly)	Bolt-on, and replaceable full-length cutting edges				
Skid Shoes/Wear Plates	Bolt-on, adjustable & replaceable				
Chute Rotation	Hydraulically driven sprocket				
Spout Deflector	Hydraulic operation				



SSP15 SNOW PUSHERS

- » 84" (638 lbs), 96" (688 lbs)
- » 30" Moldboard, 29" depth
- » AR400 Skid shoes
- » Rubber pull back blade option
- » Adjustable rubber or steel cutting edge

The SSP15 pushes snow and other loose materials straight ahead without leaving windrows on the side or damaging the pavement below when using the optional rubber snow blade.

AVAILABLE FOR: SSV65 / SSV75 / SVL65-2 / SVL75-3 / SVL97-2



SSP25 SNOW PUSHER

- » 96" (928 lbs)
- » 36" Moldboard, 35" Depth
- » Rubber pull back blade
- » Exterior gussets
- » Adjustable rubber or steel cutting edge
- » AR400 skid shoes

Push snow and slush straight ahead without leaving windrows or use the optional pull back blade to remove snow close to garage doors.

AVAILABLE FOR: SSV65 / SSV75 / SVL65-2 / SVL75-3 / SVL97-2



LM25 LIGHT MATERIAL / SNOW BUCKETS

- » 84" (719 lbs), 96" (803 lbs), 108" (869 lbs)
- » Cut out in backplate for visibility
- » BOCE optional
- » Heavy-duty construction
- » Inside bend gussets

Great for moving large volumes of loose material, snow removal, cleaning bedding and manure from events.

AVAILABLE FOR: SSV65 / SSV75 / SVL65-2 / SVL75-3 / SVL97-2



TE35 TRIP EDGE BLADE

- » 96" or 108" Widths
- » Oscillation of blade to follow contour of the surface
- » 22 Degree angle right and left
- » New HD designed tension springs
- » Radius blade rolls snow more efficiently

The trip edge design eliminates damage to surfaces and to the machine while moving large amounts of heavy snow down to the surface in a single pass. Ideal for snow contractors, municipalities, schools, and landscapers.

AVAILABLE FOR: SSV65 / SSV75 / SVL65-2 / SVL75-3 / SVL97-2



ACCESSORIES

These accessories and upgrades were designed to make your job easier, safer, and more comfortable. They help your machine be more visible, give you a smoother ride, and provide added safety features that comply with local regulations where applicable.



RADIO

AVAILABLE FOR: SSV65 / SSV75 / SVL65-2 / SVL75-3 / SVL97-2



HOSE STAY

Keep your accessory or attachment hoses organized and safe with this Hose Guide Bracket. *SVL75-3 / SVL97-2 model shown.*

AVAILABLE FOR: SSV65 / SSV75 / SVL65-2 / SVL75-3 / SVL97-2



SPECIAL APPLICATION TILT-UP DOOR (Built by KBT)

This high quality Tilt-Up Door features tough polycarbonate-glass to protect the operator from flying debris. It is required when using a hammer/breaker. Available for SVL factory Cab and SSV factory Cab or ROPS models.

AVAILABLE FOR: SSV65 / SSV75 / SVL65-2 / SVL75-3 / SVL97-2



14-PIN CONNECTOR FOR ATTACHMENT CONTROL

The industry standard 14-Pin connector is an option and is used to control 2-functions on an attachment. The 4-wire system is using industry standard connector numbers.

AVAILABLE FOR: SSV65 / SSV75 / SVL65-2 / SVL75-3 / SVL97-2



MULTI-FUNCTION CONTROL GRIP KITS

Used in conjunction with the 14-Pin connector for attachments requiring electrical on-off and momentary switch inputs. *Hand & Foot grip shown.*

AVAILABLE FOR: SSV65 / SSV75 / SVL65-2 / SVL75-3 / SVL97-2



ENGINE BONNET LOCK KIT

Engine compartment door can be locked with this optional key-lock.

AVAILABLE FOR: SSV65 / SSV75 / SVL65-2 / SVL75-3 / SVL97-2



ENGINE BLOCK HEATER

A Block Heater keeps the engine warm in cold temperatures and helps eliminate cold start engine damage. These Block Heaters are simple to install and are a reliable and efficient way to pre-heat your engine block.

AVAILABLE FOR: SSV65 / SSV75 / SVL65-2 / SVL75-3 / SVL97-2



RETRACTABLE SEAT BELT 3" WIDE

The 3" Seat Belt Kit is a replacement for the 2" seat belt shipped from the factory. Use the 3" Seat Belt Kit to increase operator comfort and as required in some states for OSHA compliance.

AVAILABLE FOR: SSV65 / SSV75 / SVL65-2 / SVL75-3 / SVL97-2



AIR RIDE SEAT SUSPENSION KIT

This Air Ride Seat Suspension Kit provides the operator with ultimate comfort when working on uneven terrain. *SVL seat model shown.*

AVAILABLE FOR: SSV65 / SSV75 / SVL65-2 / SVL75-3 / SVL97-2



STROBE LIGHT KIT

When working in cities and areas with a lot of foot traffic, a Strobe Light Kit is a great added safety feature. Consumes 1/2 Amps.

AVAILABLE FOR: SSV65 / SSV75 / SVL65-2 / SVL75-3 / SVL97-2



ROTATING BEACON LIGHT KIT

When working in cities and areas with a lot of foot traffic, a Rotary Beacon Light Kit is a great added safety feature. Consumes 5 Amps.

AVAILABLE FOR: SSV65 / SSV75 / SVL65-2 / SVL75-3 / SVL97-2



ACCESSORIES (SVL only)

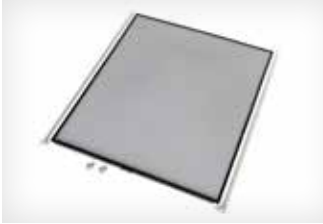

RADIATOR SCREEN KIT

The Radiator Screen reduces downtime for radiator cleaning as it can be pulled out on regular intervals to remove leaves and other debris that would otherwise collect between the cooling fan and the radiator. The radiator needs to be pulled forward to access the screen.

AVAILABLE FOR: SVL65-2 / SVL75-3 / SVL97-2



RED TAIL LIGHT KIT

Tail Lights are required by law in some states if you plan on operating on public roads.

AVAILABLE FOR: SVL65-2 / SVL75-3 / SVL97-2



REAR VIEW MIRROR

For added rear visibility.

AVAILABLE FOR: SVL65-2 / SVL75-3 / SVL97-2

ENCLOSURE KITS (for SVL ROPS models only)

Enclosure Kits transform your open ROPS SVL into a full cab machine. Offered as separately available components, such as the heater kit, you can customize your SVL cab to suit your regional weather and usage conditions. Popular kit components include side windows, as they afford the most protection from wind, rain, and dust. The intelligently designed entry door swings outward and is equipped with a release handle to separate the window from the steel door in case of attachment or debris blockage.

Swing Door Kit

This Swing Door Kit features Quick Release glass which allows the operator to easily exit the SVL in case the position of the attachment does not allow the swing door to open, or when material or debris blocks the door.



SPECIAL APPLICATION SWING DOOR – POLYCARBONATE

(includes Quick Release handles) Required for the use of hammer/breaker.

AVAILABLE FOR: SVL75-3 / SVL97-2

SPECIAL APPLICATION SWING DOOR KIT W/ FRAME AND WIPER

Front Swing Door Kit with Quick Release and Tempered Glass.

AVAILABLE FOR: SVL75-3

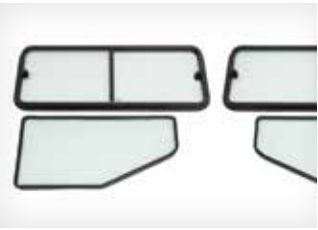

SLIDING SIDE WINDOW KIT

Sliding Side Windows allow the operator to close the cab during cold weather or open up the windows for venting when it's warm.

AVAILABLE FOR: SVL75-3



HEATER KIT

Cab Heat Kit for ROPS with Door and Side Window Kit. Working in the cold is made comfortable and efficient with this Cab Heat Kit.

AVAILABLE FOR: SVL75-3



WINDSHIELD WASHER BOTTLE KIT

Wash away dust and mud for a clear field of vision with this Front Window Washer Kit for the Swing Door.

AVAILABLE FOR: SVL75-3



ACCESSORIES & ATTACHMENTS CONTINUED



CIRCULATION FAN KIT

Circulate the air inside the enclosed cab with this easy-to-install Circulating Fan Kit.

AVAILABLE FOR: SVL75-3

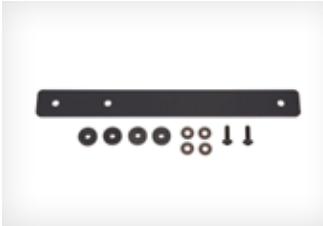

MOUNTING PLATE KIT

Mount Bracket for Magnetic Bases with Control Handles.

AVAILABLE FOR: SVL75-3 / SVL97-2





Excavators K008-5 | KX018-4 | KX030-4 | KX033-4

Kubota's compact excavators combine maneuverability, power, and reliability with economy to help you haul away more pay dirt on every job.

- › The KX030-4's operation is aided by two new features, the auto downshift feature (high to low) and the dozer blade float for back dragging
- › Compact size increases productivity in confined areas
- › Superior stability with long tumbler distance and wide variable track width (KX018-4) enables you to safely perform jobs using a host of Kubota attachments
- › Variable-width track frame can be hydraulically retracted with the switch of a lever to fit through most doorways (K008-5) and gates (KX018-4)
- › The large cab of the KX018 features ample legroom, adjustable seating, and a wide door to bring comfort to tough work
- › Digital display allows easy access and operation (KX018-4)
- › Two-pattern selection system lets operator choose ISO or SAE operating pattern
- › Easy access makes engine maintenance simple
- › With the stability and lifting capacity of a much bigger machine, the 3-ton KX033-4 offers a level of performance to handle a wide variety of tough excavating jobs
- › With a larger entrance, more legroom, and enhanced ergonomics that simplify routine operations, the KX033-4's luxurious cabin redefines operator comfort



CONVENTIONAL TAIL SWING COMPACT EXCAVATORS

Standard Tail Swing Excavators

	K008-5	KX018-4	KX030-4	KX033-4 ¹
Engine Type (Kubota)	3-cylinder, Tier 4 Final		4 Cylinder, Tier 4 Final	3-cylinder, Tier 4 Final
Engine Model	D722-E4-BH-4US		V1505-E4-BH-3USA	D1703M-DI-E4
Horsepower (gross)²	10.3	16.1	24.4	24.8
Displacement (cu. in.)	44	54.8	91.5	100.5
Overall Length (transport)	9' 0"	12' 2.1"	15' 1.1"	15' 6"
Overall Height	7' 4"	7' 7"	8' 0"	8' 1"
Overall Width	2' 10" / 2' 4" ³	4' 3.2" / 3' 3" ³	4' 11"	5' 1"
Operating Weight (lbs.)⁴	2,315	3,747	6,272	7,420
Rear Swing Clearance	12.6"	16.5"	20.9"	18.7"
Maximum Digging Depth	5' 8"	7' 9.7"	9' 7"	10' 6" / 12' 2" ¹
Maximum Dumping Height	6' 8"	7' 9.7"	10' 4"	11' 7"
Pump Capacity (gpm)	5.6	12.0	8.3	26.5
Auxiliary Hydraulic Line Flow Rate (gpm)	5.5	7.4	13.1	15.8
Bucket Breakout Force (lbf.)	2,205	3,594	6,924	8,138
Maximum Traveling Speed (mph)	1.2 / 2.5	1.4 / 2.6	1.7 / 2.7	1.9 / 2.9
Ground Contact Pressure (psi)⁴	3.41	3.7	3.9	4.365

OPTIONAL ATTACHMENTS

Hydraulic Breaker (ft./lb.)	200	300	350	500
Hydraulic Thumb	N/A		Optional	
Pin-On Bucket	8–16"	9–18"	12–24"	
Quick Attach Buckets	N/A	9–18"	12–36"	
Quick Coupler	N/A	Mechanical		Mechanical/ Hydraulic Coupler

1 – KX033-4 available with an extendable dipper arm; 2 – SAE J1995; 3 – Variable width tracks; 4 – Canopy, rubber





Excavators KX040-4 | KX057-5 | KX080-5

Get down to bedrock with these powerhouse excavators. The KX series has outstanding utility and exceptional operation.

- › Remarkable breakout force of 14,660 lbs. helps ensure high productivity in the toughest applications (KX080-5)
- › Advanced Load-Sensing Hydraulic System provides optimum oil flow to each cylinder, making operation under most loads easier and smoother
- › Hydraulic 6-in-1 blade for KX040-4 angles 25 degrees and tilts 10 degrees to make leveling and backfilling work incredibly easy
- › Oil-flow settings are adjusted and stored via a new digital panel for quick retrieval from job to job
- › Superior cabin design features air conditioner, two-pattern selection system, 2-speed travel switch, deluxe suspension seat, and retractable seat belt
- › Triple opening covers, ground-level access, and angle track frame give you easy, hassle-free maintenance

KX080-5 Excavators

- › The KX080-5 showcases an all new 7" LCD color display with an excellent working picture and clear visibility
- › Keyless start and rearview camera are now standard kits for the KX080-5
- › Operator comfort is greatly improved on the KX080-5 with the new dual adjustable seat and console as well as a much quieter cab standard



CONVENTIONAL TAIL SWING EXCAVATORS

Standard Tail Swing Excavators

	KX040-4	KX057-5	KX080-5
Engine Type (Kubota)	3-cylinder, turbocharged, Tier 4 Final	4-cylinder, Tier 4 Final	
Engine Model	Turbo Charged D1803-CR-TE4	V2607-CR-E5-BH1	V3307-CR-TE5
Horsepower¹	40.4	47.6	66.6
Displacement (cu. in.)	111.4	159.6	203.3
Overall Length (transport)	16' 8.2"	18' 1.3"	21' 1.9"
Overall Height	8' 1.8"	8' 4.4"	8' 4"
Overall Width	5' 6.9"	6' 5.2"	7' 2.6"
Operating Weight (lbs.)	9,195 ²	12,346 ²	18,596 ³
Rear Swing Clearance	17.7"	11.4"	14.2"
Maximum Digging Depth	11' 2.7"	12' 8.2"	15' 1.1"
Maximum Dumping Height	12' 9.5"	13' 8.6"	17' 2.7"
Pump Capacity (gpm)	24.4	39.4	44.6
Auxiliary Hydraulic Line Flow Rate (gpm)	17.2 / 9.8	19.8 / 9.8	26.4 / 14.7
Bucket Breakout Force (lbf.)	9,535	11,177	14,660
Maximum Traveling Speed (mph)	1.8 / 3.1	1.8 / 3.1	1.7 / 3.0
Ground Contact Pressure (psi)	4.53 ²	4.54 ²	5.25 ³

OPTIONAL ATTACHMENTS AND ACCESSORIES

Hydraulic Breaker (ft./lb.)	500	750	750 / 1200
Hydraulic Thumb		Optional	
Pin-On Bucket	12–36"	12–48"	18–60"
Pin Grabber Coupler	N/A	Optional	Optional
Quick Attach Buckets	12–39"	12–48"	18–60"
Quick Coupler	Mechanical/Hydraulic	Mechanical	
Hydraulic Augers		9"–36"	
Canopy Lights		Optional	
Travel Alarm		Optional	
Angle Blade		Optional	

1 – SAE J1995; 2 – Canopy, rubber; 3 – Cab, rubber





Excavators

U10-5 | U17 | U27-4 | U35-4 | U48-5 | U55-5

The U Series excavators offer performance, durability, convenience, and comfort to help you tackle tougher jobs in even tighter spaces.

- › Two-pattern selection system lets operator choose ISO or SAE operating pattern
 - › Zero and tight tail swing offer excellent balance, stability, and better visibility in confined areas
 - › Hydraulic variable-width track frame retracts to fit through gates, expands for stable operation (U17)
 - › Tried and true Kubota diesel engine
 - › Unique hydraulic system and large-capacity variable displacement pumps deliver exceptional boom, arm, and bucket movements in the industry
 - › The U27-4 has a dig depth of 9' 5" and provides one of the largest operator stations in the industry with a tight tail swing design
 - › Optional cabs offer spacious operator area with air conditioning, interior light, and windshield wiper/washer for comfortable all-weather operation (U35-4, U48-5, and U55-5)
 - › Digital display enhances productivity and makes operation easier
- U48-5 and U55-5:**
- › 7" LCD color display with an excellent working picture and clear visibility
 - › Keyless start and rearview camera are now optional kits for the U48-5 & U55-5
- U-10:**
- › The U10-5 now has side lever joysticks, for easier and more productive excavator operation



ZERO AND TIGHT TAIL SWING COMPACT EXCAVATORS

Zero and Tight Tail Swing Excavators

	U10-5	U17	U27-4	U35-4	U48-5	U55-5
Engine Type (Kubota)	3-cylinder, Tier 4 Final			Kubota V2607		4-cylinder, Tier 4 Final
Engine Model	D722-E4-BH-5US	D902-E4	D1105-BH	D1703M-DI-E4	Turbo Charged D1803-CR-TE5	V2607-CR-E5-BH1
Horsepower¹	10.3	16.1	20.8	24.8	38.8	47.6
Displacement (cu. in.)	44"	54.8	68.5	100.5	159.6	159.6
Overall Length (transport)	9' 9"	11' 7"	13' 6"	15' 7"	211.4	18' 0.5"
Overall Height	7' 5"	7' 8"	7' 11"	8' 1.2"	100.4	8' 4.4"
Overall Width	3'3" / 2'6"	3' 3" / 4' 1" ²	4' 11"	5' 6.9"	77.2	6' 5.2"
Operating Weight (lbs.)³	2,646	3,703	5,625	8,129	10,593	12,247
Rear Swing Clearance	0.6"	0"	1.6"	2"	1.2"	2.5"
Maximum Digging Depth	5' 11"	7' 7"	9' 5"	9' 8.9"	133.1	11' 10.3"
Maximum Dumping Height	7' 3"	8'	10'	11' 0.7"	149.2	13' 2.3"
Pump Capacity (gpm)	2.8 x 2	11.9	20.3	26.5	31.4	39.4
Auxiliary Hydraulic Line Flow Rate (gpm)	5.5	7.32	12.7	15.8	18.5	19.8 / 9.8
Bucket Breakout Force (lbf.)	2,337	3,417	7,014	7,924	7,419	11,177
Maximum Traveling Speed (mph)	1.2 / 2.5	1.4 / 2.6	1.6 / 2.7	1.9 / 2.9	1.7/3.1	1.8 / 3.1
Ground Contact Pressure (psi)²	4.3	3.8	3.321	4.89	---	4.42

OPTIONAL ATTACHMENTS AND ACCESSORIES

Canopy Lights	Optional					
Hydraulic Hammer (ft./lb.)	200	300	350	500	500	750
Hydraulic Thumb	N/A			Optional		
Pin-On Buckets	9-16"	9-18"	12-24"		N/A	12-48"
Pin Grabber	Optional					
Quick-Attach Buckets	---	9-18"	9-24"	12-36"	12-39"	12-48"
Quick Coupler	Mechanical					
Spark Arrest Muffler	Optional				DPF	
Steel Tracks	N/A		11.8"		15.7"	
Hydraulic Augers	9" - 36"					
Travel Alarm	Optional					

1 – SAE J1995; 2 – Variable Width Track; 3 – Canopy, rubber





Take Your Excavator to the highest level of performance and productivity.

Boost your performance when you combine your Kubota excavator with our heavy duty attachments, tools and accessories. The attachments, tools, and accessories are designed and performance-matched to the excavator in order to help you take your work to the next level.



EXCAVATOR BUCKETS

Your Kubota Excavator is an outstanding working tool capable of performing a wide variety of jobs. Increase the versatility of your Kubota to get the job done more quickly and easily with these high-quality buckets. Kubota buckets are designed for an easy cut, and feature tapered side plates, horizontal wear straps, an extra rigid channel, and tip radius to Kubota specifications.

Trenching Buckets

Trenching Buckets are recommended for moderate to heavy soil with loose rock. All Kubota Trenching Buckets feature quality construction with high-strength steel. Pin-on buckets are available in orange. Quick attach buckets are available in blue.



PIN-ON

Pin-on trenching buckets are available in a variety of widths from 8" to 36".

AVAILABLE FOR: K008-3 / U17 / KX018-4 / KX030-4 / KX033-4 / U35-4 / KX040-4 / KX080-5



QUICK ATTACH

Quick attach trenching buckets are available in a variety of widths from 9" to 36".

AVAILABLE FOR: U17 / KX018-4 / U27-4 / KX030-4 / KX033-4 / U35-4 / KX040-4 / U55-4 / KX057-4 / KX080-5

Ditch Cleaning / Grading Buckets

Ideal for ditch maintenance, construction, grading, and finish work (DCG buckets have no teeth). Features include a rigid top channel and bottom wear straps for extra reinforcement and longer work life. Kubota recommends the optional bolt-on cutting edge with these buckets.



PIN-ON & QUICK ATTACH

Ditch Cleaning / Grading Buckets are available in a variety of widths from 36" to 60" in Pin-On and Quick Attach models.

AVAILABLE FOR: KX040-4 / U55-4 / KX057-4 / KX080-5



Tilt Grading Buckets

Recommended for angled slope work, ditch maintenance, grading, and finish work, Tilt Grading Buckets feature 45° hydraulic tilt action. Kubota recommends using the optional bolt-on cutting edge with these buckets.

QUICK ATTACH

Tilt Grading Buckets are available in a variety of quick attach widths from 36" to 54".

AVAILABLE FOR: KX030-4 / KX033-4 / U35-4 / KX040-4 / KX080-5



Cemetery Bucket

Originally designed to dig graves, the Cemetery Bucket is ideal for any job that requires straight, vertical wall digging at maximum depths. The flat bottom and round back ensure there is no drag when curled.

36" CEMETERY BUCKET

AVAILABLE FOR: U55-4 / KX057-4

Quick Coupler

Quickly and easily exchange your excavator attachments, all without the use of tools. Quick Couplers are offered for almost the entire line of Kubota Excavators and maintain the original tip radius as pin-on buckets for powerful digging forces.



TWO HOLE QUICK COUPLER

Excellent breakout force for moderate to heavy soil conditions.

AVAILABLE FOR: U17 / KX018-4 / U55-4 / KX057-4



THREE HOLE QUICK COUPLER

Curl hole and power hole built into quick coupler. Use the curl hole for increased bucket rotation for truck loading. Use the power hole for excellent breakout force in tough digging applications.

AVAILABLE FOR: U27-4 / KX030-4 / KX033-4 / U35-4 / KX040-4 / KX080-5



HYDRAULIC QUICK COUPLER

The Kubota Konnect® Hydraulic Quick Coupler system allows operators to easily, quickly, and safely exchange attachments. T-1 steel is used in all critical wear components to ensure that this coupler has a long operation life. Hardened bushings are used at all pivot points, as well as hardened pins for wear and corrosion. Various safety features are incorporated in the coupler design to ensure safety and positive hook-up. The Kubota Konnect® system is the most convenient way to speed Kubota excavator attachment changes.

AVAILABLE FOR: KX040-4



EXCAVATOR ACCESSORIES & ATTACHMENTS CONTINUED

ATTACHMENTS

Your Kubota Excavator is designed for ultimate performance. The high-quality work tools and accessories offered here are engineered to fit your Kubota Excavator perfectly and take your machine to the next level.



HYDRAULIC THUMB KIT

The Hydraulic Thumb greatly enhances the versatility of your Kubota Excavator. It is excellent for manipulating, handling, or loading irregular-shaped objects, debris, rocks, and can even pick up logs. It is custom-designed to match bucket tip radius and is retractable (out of the way) for trenching.

AVAILABLE FOR: U27-4 / KX030-4 / KX033-4 / U35-4 / KX040-4 / U55-4 / KX057-4 / KX080-5



HYDRAULIC BREAKERS

These Hydraulic Breakers are powerful percussion hammers fitted to your Kubota excavator for demolition and recycling applications. Kubota offers Hydraulic Breakers for the entire line of excavators.

AVAILABLE FOR: K008-3 / U17 / KX018-4 / U27-4 / KX030-4 / KX033-4 / U35-4 / KX040-4 / U55-4 / KX057-4 / KX080-5



FLAIL BRUSH SHREDDER

The K4080 is a severe-duty brush shredder that has a 1/2" thick cutter drum with 5/8" ears holding 24-2.25 lb. outer knives and 12-2 lb. inside knives and does not require a case drain. The integrated thumb saddle is used in conjunction with the thumb to pick up debris and move obstacles.

AVAILABLE FOR: KX080-5



24" FROST RIPPER

Designed to pre-rip frozen ground or soil, this tool can also break roots, remove stumps, and rebar. This Frost Ripper features a single point tooth and a heavy-duty ripper shank for best penetration. An extra heavy-duty upper gusset helps prevent tooth torque on tough jobs.

AVAILABLE FOR: U55-4 / KX057-4 / KX080-5



GRADING BLADE

Grading Blades are useful for back filling, finishing grade, loose dirt, stone, and landscape finishing and shaping. The backed cutting edge has a reinforced plate and side wear plates reinforce the edge, blade, and rear plate. The edge features an extra thick cutting edge and a reinforced blade for longer life.

AVAILABLE FOR: KX030-4 / KX033-4 / U35-4 / KX040-4 / KX080-5



SOLID TINE GRAPPLE

The 36" Pin-On Solid Tine Grapple is an extremely versatile attachment designed to handle various objects such as brush, rocks, and demolition debris. This tool features a wide mouth opening for greater range when grappling brush.

AVAILABLE FOR: KX080-5



EXCAVATING RAKE

The Excavating Rake is recommended for land clearing, gathering demolition debris, and sorting material. These rakes are built with large gussets between the tines, a steel tube, and two skins for added strength.

AVAILABLE FOR: KX030-4 / KX033-4 / U35-4 / KX080-5



VIBRATORY COMPACTOR

Ho-Pacs are ideal for trench, slope, and excavation compaction. Ho-Pacs compact in densities in excess of 95% Proctor. Ho-Pacs are also used for compacting waste materials and for breaking up frozen coal. Vibratory Compactors are Allied Approved attachments.

AVAILABLE FOR: U17 / KX018-4 / KX030-4 / KX033-4 / U35-4 / KX040-4 / U55-4 / KX057-4 / KX080-5



COMPACTION WHEEL

These Compaction Wheels feature multiple wheels with foot pads staggered for even compacting in a wide variety of soil conditions. Constructed with high-quality steel with replaceable bearings and wheels, this tool is built to last and offer years of service.

AVAILABLE FOR: KX080-5



HYDRAULIC AUGER

All 75 Series hydraulic motors drive the auger through a sealed planetary gear reduction. The heavy-duty all-gear design gives these units a long life with minimal maintenance and service costs. Hydraulic Augers are Allied Approved attachments.

AVAILABLE FOR: U17 / KX018-4 / U25S / KX030-4 / KX033-4 / U35-4 / KX040-4 / U55-4 / KX057-4 / KX080-5



EA20 EXCAVATOR AUGERS

- » 4 Mounts to fit all Kubota Quick-Attach models (except U25/U27)
- » 3 Motor options: 6-15 gpm; 10-20 gpm; 15-30 gpm
- » Drive units can be used with either SA or EA mounts
- » All mounts accept cradle option

Ideal for dirt or building contractors, rental yards and fencing contractors to reach hard to access areas with an excavator.

AVAILABLE FOR: U17 / KX018-4 / U27-4 / KX030-4 / KX033-4 / U35-4 / KX040-4 / U55-4 / KX057-4 / KX080-5



EA35 EXCAVATOR AUGERS

- » 4 Mounts to fit all Kubota Quick-Attach models (except U25/U27)
- » 15-25 gpm Motor
- » Drive units can be used with either SA or EA mounts
- » All mounts accept cradle option

Allow use of an auger to dig holes using an excavators flexibility to access hard to reach areas or dig to greater depths than a CTL/skid steer is capable of.

AVAILABLE FOR: KX040-4 / U55 / KX057-4 / KX080-5



EXCAVATOR ACCESSORIES & ATTACHMENTS CONTINUED

CONTROLS, COMFORT, AND CONVENIENCE

Working with your Kubota may make you feel like a king, but a long day's work still deserves a little comfort in the cab. Alleviate some stress with Kubota Comfort & Convenience products. These radios and arm rests help make your Kubota feel like a home away from home. And the accessories enhance the versatility and productivity of your excavator.



HYDRAULIC BREAKER ACCESSORIES

Kubota offers everything you need to work with your new Hydraulic Breaker. Hose Kits, Quick Attach, and Pin-On Mounting Brackets put you and your Hydraulic Breaker to work quickly and safely.

AVAILABLE FOR: K008-3 / U17 / KX018-4 / U27-4 / KX030-4 / KX033-4 / U35-4 / KX040-4 / U55-4 / KX057-4 / KX080-5



BUCKET HANGERS

The bucket hangers are designed to convert a non-Kubota bucket to a Kubota quick attach bucket. Use these when a customer changes from another brand bucket and wants to keep the original attachments.

AVAILABLE FOR: U17 / KX018-4 / U27-4 / KX030-4 / KX033-4 / U35-4 / KX040-4 / U55-4 / KX057-4 / KX080-5



BOLT-ON CUTTING EDGES

The Cutting Edge of your Grading Bucket does the detail work. These Bolt-On Cutting Edges for Grading Buckets are an inexpensive way to strengthen the cutting edge and prolong the life of your Grading Bucket.

AVAILABLE FOR: KX030-4 / KX033-4 / U35-4 / KX040-4 / U55-4 / KX057-4 / KX080-5



SPARK ARRESTOR MUFFLERS

Working in extremely dry brush and grass may require the added safety of a Spark Arrestor. Order the Spark Arrestor Muffler as a replacement for the standard muffler. A Heat Shield (shown attached to the muffler) is required to complete the package.

AVAILABLE FOR: K008-3 / U27-4 / KX030-4 / KX033-4 / U35-4



SCREEN TYPE SPARK ARRESTOR MUFFLER

Kubota also offers a Screen Type Spark Arrestor for installation in the muffler's exhaust pipe for certain excavator models.

AVAILABLE FOR: K008-3 / KX018-4 / U27-4



TRAVEL ALARMS

Get to and from the job site safely with a Travel Alarm Kit. Alert other workers that your Excavator is on the move.

AVAILABLE FOR: U17 / KX018-4 / U27-4 / KX030-4 / KX033-4 / U35-4 / KX040-4 / U55-4 / KX057-4 / KX080-5



CANOPY LIGHT KITS

Extend your work hours on dark days and late nights with a Canopy Light Kit. The boom light illuminates the bucket area. Canopy Light Kits illuminate the surrounding area.

AVAILABLE FOR: U17 / KX018-4 / U27-4 / KX030-4 / KX033-4 / U35-4 / KX040-4 / U55-4 / KX057-4



STROBE LIGHT KIT

When working in areas where high visibility is required, a Strobe Light Kit is a great added feature. Available for cabs only.

AVAILABLE FOR: U35-4 / KX040-4 / KX033-4 / KX057-4 / U55-4 / KX080-5

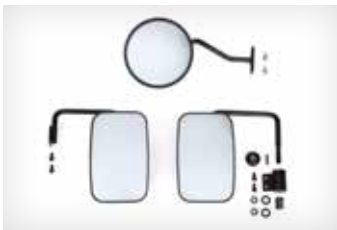

MIRROR KIT FOR CABS

Use these Mirror Kits to monitor movement of construction vehicles, equipment, and personnel within the work zone.

AVAILABLE FOR: U27-4 / U35-4 / KX033-4 / KX040-4 / U55-4 / KX057-4



BLOCK HEATER KITS

A Block Heater keeps the engine warm in cold temperatures and helps improve cold engine starting performance. These Block Heaters are simple to install and are a reliable and efficient way to pre-heat your engine.

AVAILABLE FOR: KX018-4 / U27-4 / KX030-4 / KX033-4 / U35-4 / KX040-4 / U55-4 / KX057-4 / KX080-5



STEEL TRACK KITS

Some of our customers are looking for longer track life under operating conditions such as sharp stones, recycling, and demolition applications. Steel Tracks are more durable under those conditions, and experience less damage to the track.

AVAILABLE FOR: KX030-4 / KX033-4 / KX040-4 / U55-4 / KX057-4 / KX080-5



WIDE STEEL TRACKS / DOZER BLADE EXTENSION KIT

Wide Steel Tracks provide better flotation and decreased ground pressure, reducing damage to sensitive surfaces. Wide Steel Tracks enhance machine stability as well, especially over the side. Be sure to install the Dozer Blade Extension Kit so that the blade and track width match.

AVAILABLE FOR: KX080-5



EXCAVATOR ACCESSORIES & ATTACHMENTS CONTINUED



ADDITIONAL COUNTERWEIGHT KIT

Use the Additional Weight Kit with Thumb applications in combination with large loads or heavy attachments.

AVAILABLE FOR: KX080-5



BRUSH GUARD KIT

Used for excavation, demolition, waste handling, construction or demolition sorting, and scrap-handling applications, this front- and top-operator protective guard meets the requirements of ISO 10262 1998 Level II Top, Front Guard.

AVAILABLE FOR: KX080-5



TWO-WAY SERVICE PORT KIT

The K008-3 is equipped with a one-way service port for Hydraulic Breakers. Enhance the versatility and attachment use of your K008-3 with this Two-Way Service Port Hydraulic Kit to operate an Auger or similar attachment.

AVAILABLE FOR: K008-3



3" SEAT BELT KITS

The 3" Seat Belt Kit is a replacement for the 2" seat belt shipped from the factory. Use the 3" Seat Belt Kit to increase operator comfort and as required in some states for OSHA compliance.

AVAILABLE FOR: U17 / KX018-4 / U27-4 / KX030-4 / KX033-4 / U35-4 / KX040-4 / U55-4 / KX057-4 / KX080-5



TRAVEL PEDAL KIT

For our customers that want to keep their hands on the pilot controls when operating, install the optional Travel Pedal Kit for foot operation.

AVAILABLE FOR: KX018-4 / U27-4



RADIOS

Enjoy your favorite music or stay tuned to the latest weather forecast with this outstanding AM/FM/WB Radio with MP3 Port. Most excavators are radio ready, including speakers and antenna. Check your price book for details.

AVAILABLE FOR: U27-4 / KX030-4 / KX033-4 / U35-4 / KX040-4 / U55-4 / KX057-4 / KX080-5



Wheel Loaders R430 | R540 | R640

Our highly versatile R Series wheel loaders are equipped with features to offer high visibility, unrelenting power, and productivity for many worry-free years to come.

- › 4-wheel drive, 100% on-demand differential lock, and rear frame oscillation provide excellent traction and stability
- › The ultra-comfortable, enclosed cab helps ensure year-round comfort with great visibility, a suspension seat, and hanging-type foot pedals
- › Easy access makes engine maintenance simple
- › Equipped with Kubota's own powerful Tier 4 Final diesel engine
- › Joystick mounted FnR switch allows on-the-go directional changes without clutching or braking (Only on the R540 and R640 models)
- › Make fast, safe, and easy attachment changes with the Quick Coupler

R40 Wheel Loader

- › Improved visibility - larger front window; full size right window (door size); new delta shaped wheel loader arms
- › Operator comfort - moved console of switches to the right side of the cab increasing foot and leg space; R540 multi function control lever is now standard



WHEEL LOADERS

Wheel Loaders

	R430 Canopy / Cab	R540 Canopy / Cab	R640 Canopy / Cab
Engine Type (Kubota, liquid-cooled, diesel)	3-cylinder, Turbocharged, Tier 4 Final	4-cylinder, Tier 4 Final	4-cylinder, turbocharged, Tier 4 Final
Engine Model	Turbo Charged D1803-CR-TIE4-WL5	V2607-CR-E5-WL	Turbo Charged V2607-CR-TE5-WL
Horsepower (gross)*	47.6	51.0	64.3
Operating Weight (lbs.)	7,758 / 8,232	9,888 / 10,285	11,177 / 11,563
Bucket Breakout Force (lbf.)	5,215	7,761	10,415
Loader Boom Linkage	Hybrid Link		Hybrid
Standard Bucket Capacity (cu. yd.)	0.5	0.85	1.0
Tipping Load Straight w/ Bucket (lbs.)	5,335 / 5,743	6,437 / 6,768	7,452 / 7,760
Tipping Load Straight w/ Pallet Forks (lbs.)	3,494 / 3,770	4,960 / 5,202	5,820 / 6,063
Tipping Load Full Turn w/ Bucket (lbs.)	4,596 / 4,949	5,644 / 5,930	6,526 / 6,812
Tipping Load Full w/ Pallet Forks (lbs.)	3,009 / 3,251	4,365 / 4,586	5,115 / 5,313
Rated Operating Capacity (SAE 50% w/ Bucket (lbs.))	1,504 / 1,625	2,822 / 2,965	3,263 / 3,406
Rated Operating Capacity w/ Pallet Forks (lbs.)	2,298 / 2,474 w/bucket	2,183 / 2,293	2,558 / 2,657
Angle of Articulation	40°		± 40°
Frame Oscillation	± 8°		± 8°
Dump Clearance	7' 2"	8' 0"	7' 9"
Hinge Pin Height	9' 2"	10' 7"	10' 8"
Reach Fully Raised	2' 9"	2' 7"	2' 9"
Turn Radius (loader clearance)	12' 1"	13' 8"	13' 10"
Turn Radius (tire clearance)	10' 1"	11' 1"	12' 0"
Overall Length w/ Bucket	14' 4"	17' 8"	18' 0"
Overall Width w/o Bucket	5'	5' 7"	5' 11"
Overall Height	8' 3"	8' 1"	8' 2"
Tread	3' 10"	4' 5"	4' 7"
Wheelbase	5' 10"	6' 5"	6' 7"
Auxiliary Hydraulic Flow (gpm)	11.2	14.2	17.8
Brakes – Service	Enclosed wet disc	Enclosed, self-adjusting, wet disc	
Brakes – Parking	Spring applied hydraulic released wet disc	Spring applied, hydraulic release, wet disc	
Front/Rear Axle Traction Lock	Limited slip differential	Diff-lock (both axles), 100%, on-demand	
Transmission Type		HST, 2-speed	
Traction Force (lbs.)	5,485	6,541	8,588
Travel Speed (mph)		0 - 12.4	

ADDITIONAL ATTACHMENTS AND ACCESSORIES

Backhoe	Rear		N/A
Light Material Bucket (cu. yd.)	0.75	1.0	1.5
Pallet Fork			48"
Scrap Grapple Bucket			72"

* SAE J1995



Loaders / Landscapers B26 | L47 | M62

Our unique lineup of Tractor Loader Backhoes is engineered to save you time and effort on every job.

- › The HST Plus transmission* provides the user with auto throttle advance, hydro dual speed, HST response control, and stall guard plus
- › The throttle-up switch* mounted on the loader joystick allows the operator to increase the hydraulic flow to the front end loader, without increasing vehicle speed
- › Backhoes are quick-attach, enabling the optional attachment of Cat. I or Cat. II** 3 point hitch
- › Powered by reliable Kubota diesel engines
- › Backhoe crawling mode* allows the operator to creep forward or backward without repositioning the seat
- › Quick engagement of PTO through electric switch for simple engage and disengagement while operating. Conveniently located, “push and turn” starts and one push stops the PTO
- › Kubota’s hydraulic 2-lever quick coupler* lets you quickly and easily attach and detach front implements



LOADER / LANDSCAPER TRACTORS

Loaders/Landscapers

	B26	L47	M62
Engine Type (Kubota, liquid-cooled, diesel)	E-TVCS, 3-cylinder, Tier 4 Final	EPA Tier 4 Final	
Horsepower (gross)*	25.5	47.1	63
Displacement (cu. in.)	68.5	148.5	
Overall Length (w/ backhoe)	198.0"	233.9"	252.9"
Overall Width (w/ loader)	60"	72.5"	84.8"
Wheelbase	62.2"	72.5"	80.7"
Transmission	Hydrostatic (HST) infinite 3-range	HST Plus 6-range	
Tractor Weight (lbs.) (w/ loader, backhoe, and ROPS/FOPS)	4,001	7,205	8,925

COMPATIBLE IMPLEMENTS

Backhoe	BT820	BT1000B	BT1400
Front Loader	TL500	TL1300	TL1800

BACKHOE SPECIFICATIONS

	BT820	BT1000B	BT1400
Digging Depth	99.8"	121"	169.8"
Loading Height	77.3"	92.9"	130.9"
Bucket Sizes	12", 18", 24"	12–36"	12–36"

FRONT LOADER SPECIFICATIONS

	TL500	TL1300	TL1800
Maximum Lift Height	94.5"	113.9"	126.1"
Lift Capacity (lbs.) at Full Height/Pivot Point	1,301	2,848	3,960
Material Bucket	60"	72"	84"
Loader Feature	Mechanical spill guard	Automatic hydraulic self-leveling	

* SAE J1995





Whether you're hauling half a ton of cargo on the job site or feeding livestock out in the pastures, the smooth-riding, hard-charging RTV-X gets it done.

- › VHT-X (Variable Hydraulic Transmission) - Kubota's VHT-X provides exceptional performance on various terrain with smooth and powerful acceleration. Low-speed driving is made exceptional through smooth throttle control, great traction and maneuverability with or without loads
- › Dynamic Brakes - One of the major benefits of the VHT-X transmission is the dynamic braking, which slows the vehicle down when you remove your foot from the throttle. It also provides drivers a sense of confidence as they travel down slopes. The ability to utilize one pedal operation creates a great experience, for both novice and experienced drivers alike providing a heightened sense of security
- › Towing Capacity - Standard two-inch hitch receivers are located at the front and back. The back receiver lets you tow up to 1,300 lbs.* of gear. (*See owner's manual for detail.)
- › Prokonvert™ Cargo Bed - When you have a job to get done, being able to easily load and unload the cargo bed is critical. The new bed design allows you to open from either side, or the rear - especially useful for easily loading items in the back of the bed
- › Flatbed Conversion - For customers loading bulky or awkwardly shaped materials, or having to load the bed with another piece of equipment, customers can easily convert the cargo bed into a flatbed without the use of any tools. A shining example of capability re-imagined
- › LED Headlights - For the jobs that begin well-before the sun rises and continue on long-after the sun sets, the new LED headlights not only look cool, they illuminate the way so you can stay focused on the job at hand



UTILITY VEHICLES

RTV-X

Grade	Basic	Standard	Premium
Engine Type (Kubota)	3-cylinders, 4-cycle, diesel, OHV		
Horsepower (gross)**	24.8		
Transmission	Variable Hydro Transmission (VHT-X)		
Power Steering	Hydrostatic power steering		
Brakes (front/rear)	Wet disc brake		
Fuel Capacity (gal.)	7.9		
Weight (lbs.)	2,050	2,072	2,099
Overall Height	79.5"		
Ground Clearance	10.4" - 10.5"		
Width	63.2"		
Cargo Capacity (lbs.)	1,102		
Body Color	Orange	Orange / Camouflage***	Orange, Camouflage, Desert Sand

ADDITIONAL ACCESSORY OPTIONS

Alloy Wheels	Basic does not offer alloy wheels, only steel wheels. Only the standard and premium lines.	(Orange, Camo) Available (Desert Sand) Standard	
Hydraulic Bed Lift	Optional	Standard	Standard
Standard Front Guard	Basic	Standard	Premium
Spray-On Bed Liner	N/A	(Orange) Available, (Camo) Standard	Standard

* Manufacturer estimate; ** SAE J1995; *** Realtree® AP Camouflage is a registered trademark of Jordan Outdoor Enterprises, Ltd.

Visit KubotaUSA.com for a full listing of accessories and attachments.





The RTV-X1130 has the capability, power, and performance to get the job done.

- › Full Steel Frame/CV Joint Guards - The high-rigidity steel frame isolates the occupants from noise, vibrations, and harshness. With structural strength that few in the industry can match, this durable frame can take years of punishment from heavy loads and rough terrain*. (*See owner's manual for details)
- › VHT-X (Variable Hydraulic Transmission) - Kubota's VHT-X provides exceptional performance on various terrain with smooth and powerful acceleration. Low-speed driving is made exceptional through smooth throttle control, great traction and maneuverability with or without loads
- › Wet Disc Brakes - The RTV-X series uses multi-disc wet brakes which provide long brake life. You'll also feel more secure, especially when traveling down long inclines, knowing that dynamic braking is helping to provide additional braking power and greater driving control
- › Standard Prokonvert™ Cargo Bed - It's not enough to get you there and back. You need to get your stuff there and back, as well. This heavy-duty 6ft steel cargo bed can do that for you, carrying more than a half-ton (1212 lbs.) of tools, firewood, gear, supplies...whatever you need to haul from here to there and back again
- › Standard Hydraulic Dump Bed - Dump sand, gravel, turf, or just about anything you can think of, from the RTV-X1130's whopping, 26.1 cu. ft. capacity cargo bed. Cargo that could take significant physical strength and time to unload can now be dumped with little effort in mere seconds



RTV-X1130

RTV-X1130 Worksite

Body Color	Kubota Orange	RealTree® AP Camouflage***
Engine Type (Kubota)	3-cylinders, 4-cycle, diesel, OHV	
Horsepower (gross)**	24.8	
Transmission	Variable Hydro Transmission (VHT-X)	
Power Steering	Hydrostatic power steering	
Brakes (front/rear)	Wet disc brake	
Fuel Capacity (gal.)	7.9	
Weight (lbs.)	2,340	
Overall Height	80"	
Ground Clearance	11.3" / 9.4"	
Width	63"	
Cargo Capacity (lbs.)	1,212	

ADDITIONAL ACCESSORY OPTIONS

Wheels	Steel	
Hydraulic Bed Lift	Standard	
Front Guard	Standard	Premium
Spray-On Bed Liner	Standard	

** SAE J1995; *** Realtree® AP Camouflage is a registered trademark of Jordan Outdoor Enterprises, Ltd.

Visit KubotaUSA.com for a full listing of accessories and attachments.





Experience luxurious driving comfort with the optional factory-installed, climate-controlled cab.

- › RTV-X1100C features a premium grand cab that is built around a unibody chassis frame. The quiet, rattle-free environment and standard, factory installed A/C, heat, and defrost ensure that you'll ride in comfort year round
- › The RTV-X1100C boasts 24.8-horsepower* Kubota diesel engine for demanding jobs that require plenty of power
- › 1,300 lbs. towing capacity with standard front and rear two-inch hitch receivers at the front and back
- › Up to 15.2 cubic feet of cargo — heavy-duty steel cargo box can carry up to a half-ton (1,102 lbs.) of tools, firewood, gear, supplies, and whatever you need to haul from here to there and back again
- › Front PTO attachment options take your RTV-X1100C to a new level of versatility and performance
- › 2-speed in-line shift allows you to shift less often and maintain better control
- › Front and rear independent suspension ensures an exceptional ride, and extra duty IRS (Independent Rear Suspension) sets a new standard for durability
- › Kubota's advanced VHT-X (Variable Hydraulic Transmission) offers a wide torque band, advanced designed HST motor, and large oil coolers to boost durability and increase performance
- › VHT-X transmission's dynamic braking provides additional braking power for driving control, making you feel more secure, especially when traveling down long inclines



UTILITY VEHICLES

RTV-X1100C

	RTV-X1100C	
Engine Type (Kubota)	3-cylinder, diesel	
Horsepower (gross)**	24.8	
Transmission	Variable Hydro Transmission (VHT-X)	
Power Steering	Hydrostatic power	
Brakes (front/rear)	Wet disc brake	
Fuel Capacity (gal.)	7.9	
Weight (lbs.)	2,370	
Overall Height	82.3"	
Ground Clearance	10.4"	
Width	65.4"	
Cargo Capacity (lbs.)	1,102	
Body Color	Orange	Camouflage***

ADDITIONAL ACCESSORY OPTIONS

Alloy Wheels	Optional or Standard	Optional
Hand Throttle	Standard	
Hydraulic Bed Lift	Standard	
Steel Front Guard	Center, bumper, and lens	
Spray-On Bed Liner	Optional	

** SAE J1995; *** Realtree® AP Camouflage is a registered trademark of Jordan Outdoor Enterprises, Ltd.

Visit KubotaUSA.com for a full listing of accessories and attachments.





From spacious cargo capacity to generous seating for up to four adults, this utility workhorse gives you the best possible performance and comfort across a wide range of jobs.

- › K-vertible Cargo Transformation System — two- and four-passenger configuration in less than a minute
- › Powerful Kubota 3-cylinder, liquid-cooled, 4-cycle, 24.8-horsepower* diesel engine
- › Exclusive Kubota 2-range VHT-X (Variable Hydraulic Transmission)
- › Top speed of 25 mph and 1,300 lbs. towing capacity
- › Quick, responsive hydrostatic power steering
- › Dealer-installed full cab enclosure available
- › ROPS that meets both OSHA and SAE requirements for both front and back row seats provides cleaner look and easier cargo loading
- › 20% larger, clog-resistant radiator for simpler maintenance and improved performance
- › Wet disc brakes for smooth, consistent braking and excellent durability
- › Independent front and independent rear suspensions and a long wheelbase deliver a smooth, stable ride
- › Standard 19.1 cu. ft./9.9 cu. ft. (two-seat/four-seat configurations) cargo bed with hydraulic lift capability in either configuration (up to 1,102 lbs. capacity)



UTILITY VEHICLES

RTV-X1140

RTV-X1140

Engine Type (Kubota)	3-cylinder, 4-cycle, diesel, OHV	
Horsepower (gross)*	24.8	
Transmission	Variable Hydro Transmission (VHT-X)	
Power Steering	Hydrostatic power	
Brakes (front/rear)	Wet disc brake	
Fuel Capacity (gal.)	7.9	
Weight (lbs.)	2,370	
Overall Height	79.7"	
Ground Clearance (rear axle)	9.4"	
Width	63.2"	
Cargo Capacity (lbs.)	1,102 (long) / 661 (short)	
Body Color	Orange	Camouflage**

ADDITIONAL ACCESSORY OPTIONS

Alloy Wheels	Optional or Standard	Optional
Hand Throttle	Standard	
Hydraulic Bed Lift	Standard	
Steel Front Guard	Center and bumper	Center, bumper, and lens
Spray-On Bed Liner	Optional	

* SAE J1995; ** Realtree® AP Camouflage is a registered trademark of Jordan Outdoor Enterprises, Ltd.

Visit KubotaUSA.com for a full listing of accessories and attachments.



KUBOTA SERVICES

KUBOTA PARTS

Kubota Tractor Corporation (KTC) Parts operations provide customer parts support, parts, and manuals through Kubota's national dealer network. We support our dealers with four large warehouses located strategically throughout the United States and two super warehouses in Japan.

KTC Parts offers a full line of O.E.M. service and maintenance parts designed and engineered to original factory specifications to keep your Kubota equipment operating at peak performance.

KUBOTA ORANGE PROTECTION PROGRAM®

The Kubota Orange Protection Program gives you the opportunity to extend your coverage, without interruption, by one or two years. You can purchase your warranty extension through your Kubota dealer any time before the expiration of the regular Kubota Limited Warranty.¹

BENEFITS AT A GLANCE

- > Comprehensive coverage
- > Protects your investment
- > Provides peace of mind
- > Reliability of genuine Kubota parts
- > Extends both the Basic and applicable Power Train coverage
- > Administered by Kubota Tractor Corporation
- > Sold and serviced by your authorized Kubota Extended Warranty dealer
- > Financing available, if purchased at the same time as your tractor
- > No deductibles
- > Fully transferable

FOR MORE INFORMATION:

VISIT YOUR LOCAL KUBOTA DEALER OR CALL 888-398-9782

KUBOTA CREDIT CORPORATION, U.S.A.

Since 1982, Kubota has extended a wide range of financing alternatives to customers through Kubota Credit Corporations, U.S.A. (KCC). KCC offers competitive interest rates, flexible down payments, monthly and seasonal payment terms, and a Kubota-sponsored property damage insurance program. Kubota dealers can tailor a variety of finance programs² to meet the specific requirements of their customers.

FOR MORE INFORMATION, VISIT YOUR LOCAL KUBOTA DEALER OR WWW.KUBOTACREDITUSA.COM

1 - Orange Protection is available in Florida for Commercial Customers only.

2 - Subject to credit approval through Kubota Credit Corporation, U.S.A.



**KUBOTA-BACKED, NO DEDUCTIBLE
EXTENDED WARRANTY SOLUTION**



KTAC INSURANCE AGENCY

Created specifically for Kubota customers, KTAC Insurance is a Kubota-endorsed physical damage insurance program providing “all risk” protection.*

BENEFITS AT A GLANCE

- > Coverage against flood, wind, infestation, upset and collision, falling objects, theft, fire, vandalism, and more
- > In-transit and off-property protection
- > Low \$250 deductible
- > Convenient payment options
- > Transportation reimbursement

KCC customers also receive original sales price protection (including taxes and fees)** for the first 60 months of the finance agreement.

FOR MORE INFORMATION, CONTACT A KTAC REPRESENTATIVE AT 800-348-5802 OR VISIT WWW.KTACINSURANCEAGENCY.COM.

* See policy for details

**This is a summary of the Kubota-Endorsed Property Damage Insurance Program. This information is descriptive only and is not intended to be a solicitation or an offer to sell any insurance product or service, nor is the information a complete description of all of the terms, conditions and exclusions applicable. Actual coverage is subject to the language of the policy issued. This policy is underwritten by Ohio Indemnity Company.

KUBOTA LEASING

In this credit-tight economy, leasing is critical to getting the Kubota equipment your business needs to grow. With the new Kubota Leasing program, commercial customers have access to flexible leasing that makes the full Kubota product line more affordable.

PROGRAM HIGHLIGHTS INCLUDE:

- > Affordable monthly payments
- > Fast, easy application process
- > Application only required up to \$150,000
- > Same-day credit decisions with complete information
 - > Transactions starting at \$3,000 and up
 - > 24-, 36-, 48- or 60-month terms
- > Flexible structures to match your cash flow and budget



Kubota Tractor Corporation reserves the right to change the stated specifications without notice. This brochure is for descriptive purposes only and reasonable efforts were used to set forth the contained information; some items shown may be optional and some products shown may not be available at all dealerships. Kubota disclaims all representations and warranties, express or implied, or any liability from the use of this brochure. For complete warranty, safety and product information, consult your local Kubota dealer and the operator's manual. Power (HP/KW) and other specifications are based on various standards or recommended practices. For your safety, Kubota strongly recommends the use of a Rollover Protective Structure (ROPS) and seat belt in almost all applications. This brochure is intended for the United States and US territories only. For information regarding Kubota products or services outside these areas, see Kubota Corporation's global web site. Kubota does not provide parts, warranty or service for any Product which is re-sold or retailed in any country other than the country for which the Product(s) were designed or manufactured.



Kubota[®]

KUBOTA TRACTOR CORPORATION

1000 Kubota Drive
Grapevine, TX 76051
KubotaUSA.com



This brochure is for descriptive purposes only. Please contact your local Kubota dealer for warranty and safety information. See dealer for details.

77700-13570 - Rev. 11-23 Construction Equipment Full Product Line Brochure | © 2023 Kubota Tractor Corporation